



CPCTM Series

INSTRUCTION MANUAL

INTRODUCTION.....	4
WARNING.....	4
ASSEMBLY.....	6
ASSEMBLING THE CPC.....	6
<i>Setting up the Tripod</i>	6
<i>Adjusting the Tripod Height</i>	7
<i>Attaching the CPC to the Tripod</i>	7
<i>Adjusting the Clutches</i>	8
<i>The Star Diagonal</i>	8
<i>The Eyepiece</i>	9
<i>The Finderscope</i>	9
Finderscope Installation.....	9
Aligning the Finderscope.....	10
Attaching the Hand Control.....	10
Powering the CPC.....	11
HAND CONTROL.....	12
<i>Hand Control Operation</i>	13
<i>Alignment Procedures</i>	13
Sky Align.....	13
Auto Two-Star Align.....	15
Two Star Alignment.....	16
One-Star Align.....	16
Solar System Align.....	16
EQ North / EQ South Alignment.....	17
CPC Re-Alignment.....	18
<i>Selecting an Object</i>	18
<i>Slewing to an Object</i>	19
<i>Finding Planets</i>	19
<i>Tour Mode</i>	19
<i>Constellation Tour</i>	20
<i>Direction Buttons</i>	20
<i>Rate Button</i>	20
<i>Setup Procedures</i>	20
Tracking Mode.....	20
Tracking Rate.....	21
View Time-Site.....	21
User Defined Objects.....	21
Get RA/DEC.....	22
Goto R.A/Dec.....	22
Identify.....	22
Precise GoTo	22
<i>Scope Setup Features</i>	23
Steup Time-Site.....	23
Anti-backlash.....	23
Slew Limits.....	23
Filter Limits.....	23
Direction Buttons.....	24
Goto Approach.....	24
Autoguide Rates.....	24
Cordwrap.....	24
<i>Utility Features</i>	24
GPS On/Off.....	24
Wedge Align.....	24
Periodic Error Correction.....	24
Light Control.....	24
Factory Settings.....	24
Version.....	24
Get Alt-Az.....	25
Goto Alt-Az.....	25
Hibernate.....	25
Sun Menu.....	25
Scrolling Menu.....	25

TELESCOPE BASICS	27
<i>Image Orientation</i>	27
<i>Focusing.....</i>	27
<i>Calculating Magnification</i>	28
<i>Determining Field of View</i>	28
<i>General Observing Hints.....</i>	28
ASTRONOMY BASICS.....	30
<i>The Celestial Coordinate System.....</i>	30
<i>Motion of the Stars</i>	31
<i>Polar Alignment (with optional Wedge).....</i>	32
Wedge Align	32
<i>Finding the North Celestial Pole.....</i>	32
Declination Drift Method of Polar Alignment.....	33
CELESTIAL OBSERVING	35
<i>Observing the Moon</i>	35
Lunar Observing Hints	35
<i>Observing the Planets</i>	35
Planetary Observing Hints.....	35
<i>Observing the Sun</i>	36
Solar Observing Hints	36
<i>Observing Deep Sky Objects</i>	36
<i>Seeing Conditions.....</i>	36
<i>Transparency.....</i>	36
<i>Sky Illumination</i>	36
<i>Seeing.....</i>	37
CELESTIAL PHOTOGRAPHY	38
<i>Short Exposure Prime Focus Photography.....</i>	38
<i>Eyepiece Projection.....</i>	39
<i>Long Exposure Prime Focus Photography.....</i>	40
<i>Periodic Error Correction (PEC)</i>	41
Using Periodic Error Correction.....	41
<i>Terrestrial Photography.....</i>	42
Metering	42
Reducing Vibration	42
F/6.3 with Reducer/Corrector.....	42
Auto Guiding.....	43
TELESCOPE MAINTENANCE	44
<i>Care and Cleaning of the Optics.....</i>	44
<i>Collimation.....</i>	44
OPTIONAL ACCESSORIES.....	46
APPENDIX A - TECHNICAL SPECIFICATIONS	48
APPENDIX B - GLOSSARY OF TERMS.....	49
APPENDIX C – LONGITUDES AND LATITUDES.....	52
APPENDIX D – RS-232 CONNECTION.....	57
APPENDIX E – TIME ZONE MAP.....	58
SKY MAPS.....	60
OBSERVATIONAL DATA SHEET	66

Introduction

Congratulations on your purchase of the Celestron CPC telescope! The CPC GPS ushers in the next generation of computer automated telescopes. The CPC series uses GPS (Global Positioning System) technology to take the guesswork and effort out of aligning and finding celestial objects in the sky. Simple and easy to use, the CPC with its on-board GPS, is up and running after locating just three celestial objects. It's so advanced that once you turn it on, the integrated GPS automatically pinpoints your exact coordinates. No need to enter the date, time, longitude and latitude or even know the name of a single star in the sky.

If you are new to astronomy, you may wish to start off by using the CPC's built-in Sky Tour feature, which commands the CPC to find the most interesting objects in the sky and automatically slews to each one. Or if you are more experienced, you will appreciate the comprehensive database of over 40,000 objects, including customized lists of all the best deep-sky objects, planets and bright double stars. No matter at what level you are starting out, the CPC will unfold for you and your friends all the wonders of the Universe.

Some of the many standard features of the CPC include:

- Integrated Global Positioning System for easy alignment.
- Fully enclosed optical encoders for position location.
- Ergonomically designed hand controller – built into the side of the fork arm.
- Database filter limits for creating custom object lists.
- Storage for programmable user defined objects; and

Many other high performance features!

The CPC's deluxe features combined with Celestron's legendary Schmidt-Cassegrain optical systems give amateur astronomers the most sophisticated and easy to use telescopes available on the market today.

Take time to read through this manual before embarking on your journey through the Universe. It may take a few observing sessions to become familiar with your CPC, so you should keep this manual handy until you have fully mastered your telescope's operation. The CPC hand control has built-in instructions to guide you through all the alignment procedures needed to have the telescope up and running in minutes. Use this manual in conjunction with the on-screen instructions provided by the hand control. The manual gives detailed information regarding each step as well as needed reference material and helpful hints guaranteed to make your observing experience as simple and pleasurable as possible.

Your CPC telescope is designed to give you years of fun and rewarding observations. However, there are a few things to consider before using your telescope that will ensure your safety and protect your equipment.

Warning



- ❑ **Never look directly at the sun with the naked eye or with a telescope (unless you have the proper solar filter). Permanent and irreversible eye damage may result.**
- ❑ Never use your telescope to project an image of the sun onto any surface. Internal heat build-up can damage the telescope and any accessories attached to it.
- ❑ Never use an eyepiece solar filter or a Herschel wedge. Internal heat build-up inside the telescope can cause these devices to crack or break, allowing unfiltered sunlight to pass through to the eye.
- ❑ Never leave the telescope unsupervised, either when children are present or adults who may not be familiar with the correct operating procedures of your telescope.



Figure 2 – The CPC Series

1	Control Panel (see below)	8	Optical Tube
2	Focus Knob	9	Schmidt Corrector Lens
3	Star Diagonal	10	Fork Arm
4	Hand Control	11	Carrying Handle
5	Eyepiece	12	Right Ascension Locking Knob
6	Finderscope	13	Tripod
7	Finderscope Quick Release Bracket	14	Accessory Tray / Center Support Bracket
A	Hand Control Port	D	Auto Guider Port
B	Auxiliary Port s	E	On/Off Switch
C	PC Interface Port	F	12v Input Jack



The CPC telescope comes completely pre-assembled and can be operational in a matter of minutes. The CPC and its accessories are conveniently packaged in one reusable shipping carton while the tripod comes in its own box. Included with your telescope are the following:

- 40mm Eyepiece – 1¼"
- 1¼" Star Diagonal
- 8x50 Finderscope and Quick Release Mounting Bracket
- 1¼" Visual Back
- Car Battery Adapter
- Heavy Duty Tripod
- NexRemote Telescope Control Software w/ RS-232 cable

Assembling the CPC

Start by removing the telescope and tripod from their shipping cartons and set the telescopes round base on a sturdy flat surface. Always carry the telescope by holding it from the lower portion of the fork arm on the hand control side and from the handle on the opposite side. Remove all of the accessories from their individual boxes. Remember to save all of the containers so that they can be used to transport the telescope. Before attaching the visual accessories, the telescope should be mounted on the tripod and the tube should be positioned horizontal to the ground.

Setting up the Tripod

For maximum rigidity, the Celestron heavy duty tripod has a leg support bracket/accessory tray. This bracket fits snugly against the tripod legs, increasing stability while reducing vibration and flexure. However, the tripod must be shipped with the leg support bracket detached so the tripod legs can collapse. To set up the tripod:

1. Hold the tripod with the head up and the legs pointed toward the ground.
2. Pull the legs away from the central column until they will not separate any further. The top of each tripod leg presses against the tripod head to indicate maximum separation.
3. Remove the tension knob, located on the central column. See figure 3-1.
4. Place the leg support bracket over the central rod so that the cups on the end of each bracket are directly underneath each leg.
5. Rotate the tension knob until the bracket is secure against the tripod legs. **Do not over tighten.**

The tripod will now stand by itself. Once the telescope is attached to the tripod, readjust the tension knob to ensure that the leg support bracket is snug. Once again, do not over tighten!

Adjusting the Tripod Height

The tripod that comes with your CPC telescope is adjustable. There is a bubble level located on the top of the tripod head to assist you in leveling the tripod. To adjust the height at which the tripod stands:

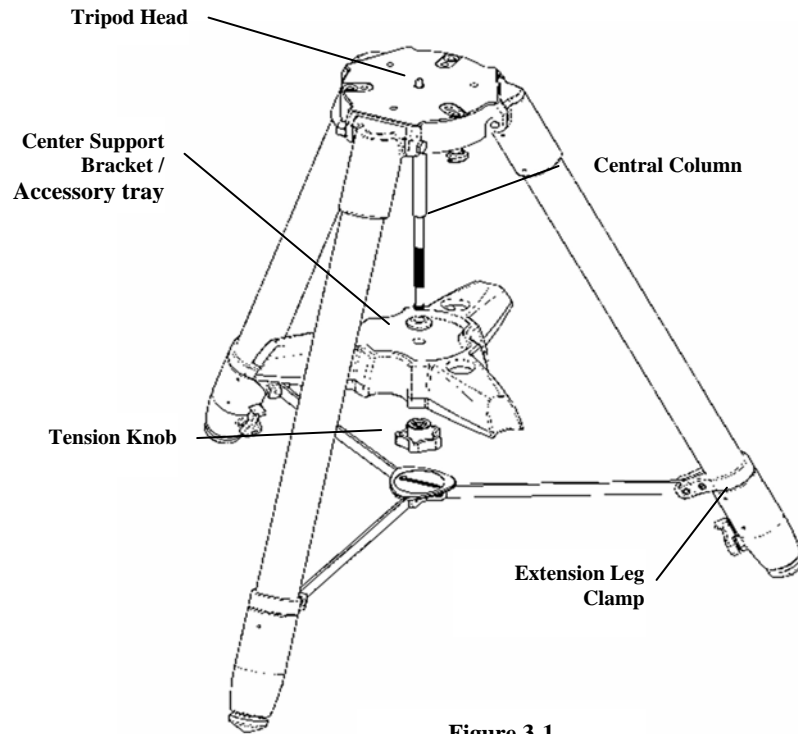

Figure 3-1

1. Loosen the extension clamp on one of the tripod legs (see figure 3-1).
2. Extend the leg to the desired height.
3. Tighten the extension clamp to hold the leg in place.
4. Repeat this process for each of the remaining legs making sure that the tripod is level when complete.

You can do this while the tripod legs are still folded together.

Remember that the higher the tripod legs are extended, the less stable it is. For casual observing, this may not pose a problem. However, if you plan on doing photography, the tripod should be set low to ensure stability. A recommended height is to set the tripod in such a manner that you can look directly into the eyepiece on the telescope with a diagonal while seated.

Attaching the CPC to the Tripod

After the tripod is set up, you are now ready to attach the telescope. The bottom of the CPC base has three threaded holes that mount to the tripod head and one hole in the center that goes over the positioning pin on the tripod head.

1. Place the center hole in the bottom of the telescope base over the positioning pin in the center of the tripod head.

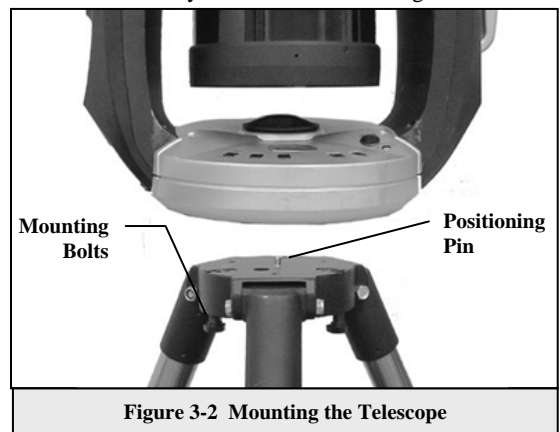

Figure 3-2 Mounting the Telescope

2. Rotate the telescope base on the tripod head until the three feet on the bottom of the base fall into the feet recesses on the top of the tripod head.
3. Thread the three attached mounting bolts from underneath the tripod head into the bottom of the telescope base. Tighten all three bolts.

You are now ready to attach the visual accessories onto the telescope optical tube.

Adjusting the Clutches

The CPC has a dual axis clutch system. This allows you to move the telescope manually even when the telescope is not powered on. However, both clutches need to be tightened down for the telescope to be aligned for "goto" use. **Any manual movement of the telescope will invalidate your telescope's alignment.**

Before attaching your visual accessories, first loosen the altitude locking knob while holding the telescope tube by the rear cell handle. Rotate the tube upwards until it is level with the ground and tighten the locking knob.

Note: When transporting your telescope, make sure that both clutches are somewhat loose; this will diminish the load placed on the worm gear assemblies and protect them from damage.

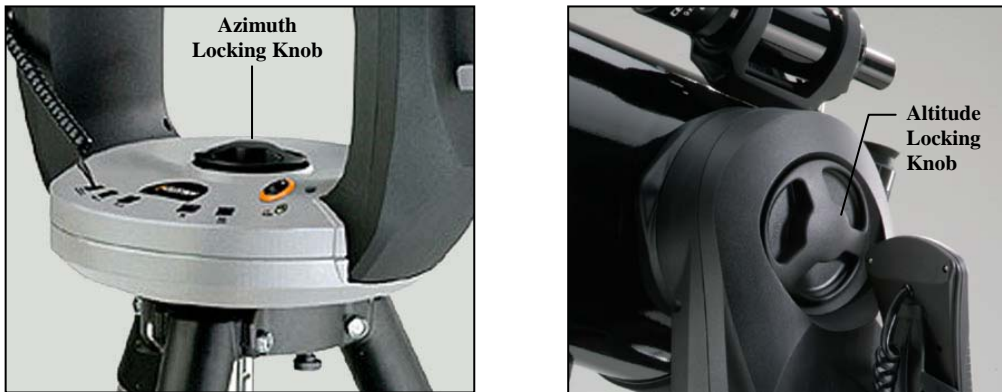

Figure 3-4 - The CPC has an altitude locking knobs (right) located on the fork arm and an azimuth locking knob (left) located on the top of the base.

The Star Diagonal

The star diagonal diverts the light at a right angle from the light path of the telescope. For astronomical observing, this allows you to observe in positions that are more comfortable than if you were to look straight through. To attach the star diagonal:

1. Turn the thumbscrew on the visual back until its tip no longer extends into (i.e., obstructs) the inner diameter of the visual back.
2. Slide the chrome portion of the star diagonal into the visual back.
3. Tighten the thumbscrew on the visual back to hold the star diagonal in place.

If you wish to change the orientation of the star diagonal, loosen the thumbscrew on the visual back until the star diagonal rotates freely. Rotate the diagonal to the desired position and tighten the thumbscrew.

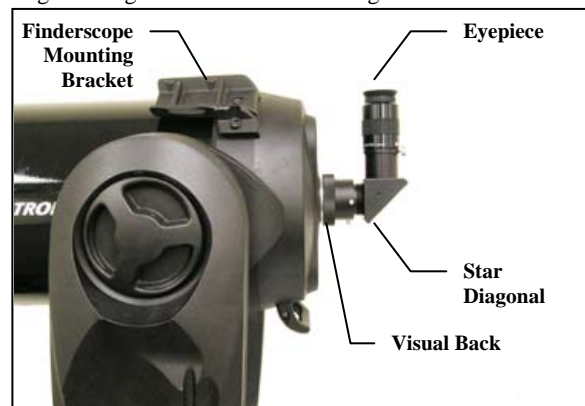

Figure 3-5 - The Visual Accessories

The Eyepiece

The eyepiece, is the optical element that magnifies the image focused by the telescope. The eyepiece fits into either the visual back directly or the star diagonal. To install the eyepiece:

1. Loosen the thumbscrew on the star diagonal so it does not obstruct the inner diameter of the eyepiece end of the diagonal.
2. Slide the chrome portion of the eyepiece into the star diagonal.
3. Tighten the thumbscrew to hold the eyepiece in place.

To remove the eyepiece, loosen the thumbscrew on the star diagonal and slide the eyepiece out.

Eyepieces are commonly referred to by focal length and barrel diameter. The focal length of each eyepiece is printed on the eyepiece barrel. The longer the focal length (i.e., the larger the number) the lower the eyepiece power or magnification; and the shorter the focal length (i.e., the smaller the number) the higher the magnification. Generally, you will use low-to-moderate power when viewing. For more information on how to determine power, see the section on “Calculating Magnification.”

Barrel diameter is the diameter of the barrel that slides into the star diagonal or visual back. The CPC uses eyepieces with a standard 1-1/4" barrel diameter.

The Finderscope

The CPC telescope comes with an 8x50 finderscope. The specifications for a finderscope stand for the magnification and the aperture, in millimeters, of the scope. So, an 8x50 finder magnifies objects eight times and has a 50mm objective lens.

Finderscope Installation

The finderscope must first be mounted in the included quick-release bracket then attached to the rear cell of the telescope. To install the finderscope:

1. Locate the finderscope mounting bracket attached to the bottom portion of the finder bracket. Loosen the two thumb screws to slide the mounting bracket from the finderscope bracket.
2. Find the two holes in the rear cell of the telescope on the top left, when looking from the back of the tube.
3. Place the mounting bracket over the two holes of the rear cell as shown in the figure 3-7.
4. Insert the screws through the bracket and into the rear cell.

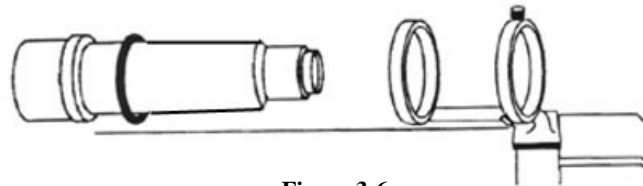

Figure 3-6

WARNING: If you remove the mounting bracket, do not completely thread the screws back into the rear cell of the telescope. The screws may be long enough to obstruct the movement of, and possibly damage the primary mirror.

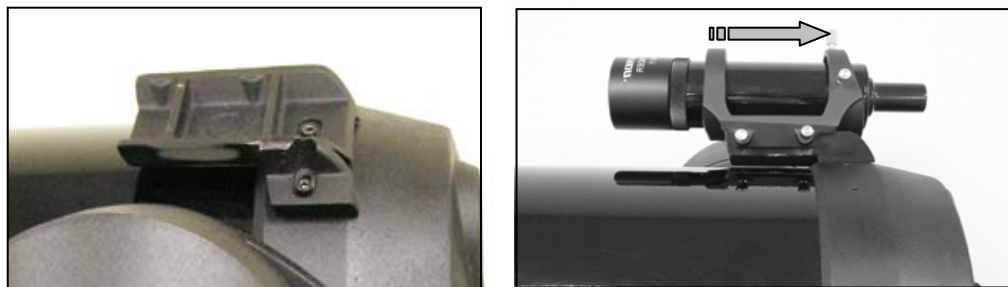

Figure 3-7

The finderscope bracket comes in two pieces; the mounting bracket (left) and the finder bracket (right)

With the bracket firmly attached to the telescope, you are ready to attach the finder to the bracket.

1. Slide the O-Ring over the back of the finderscope and position it on the tube toward the objective end of the finderscope.
2. Slide the eyepiece end of the finderscope into the front ring of the bracket (the front ring is the one without the adjustment screws), then through the back ring. It may be necessary to push down the spring loaded pivot screw so that the finder will pass through the back ring (see figure 3-8)
3. Push the finder back until the O-Ring is snug inside the front ring of the finder bracket.
4. Hand tighten the two adjustment thumb screws until they make contact with the finderscope.

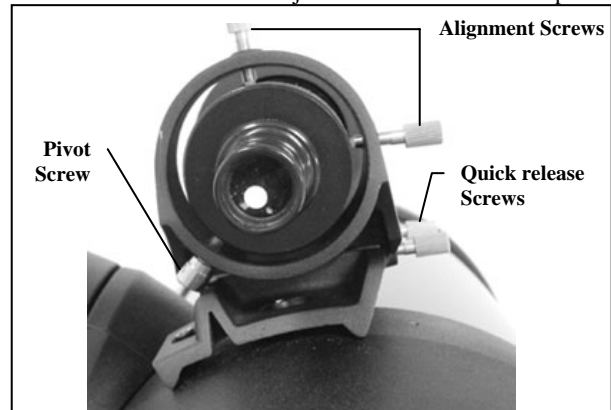

Figure 3-8

Aligning the Finderscope

The finderscope is adjusted using two adjustment screws, located on the top and on the right (when looking through the finder) of the finder bracket and a spring loaded pivot screw (located on the left side of the bracket). This allows you to turn the top adjustment screw to move the finderscope up and down, and turn the right adjustment screw to move the finderscope right to left. The spring loaded pivot screw puts constant pressure on the finder so that the adjustment screws are always making contact with the finder.

To make the alignment process a little easier, you should perform this task in the daytime when it is easier to locate objects in the telescope without the finder. To align the finder:

1. Choose a conspicuous object that is in excess of one mile away. This will eliminate any possible parallax effect between the telescope and the finder.
2. Point your telescope at the object you selected and center it in the main optics of the telescope.
3. Lock the azimuth and altitude clamps to hold the telescope in place.
4. Check the finder to see where the object is located in the field of view.
5. Adjust the thumb screws on the finder bracket, until the cross hairs are centered on the target.

Remember that the image orientation through the finder is inverted (i.e., upside down and reversed from left-to-right). Because of this, it may take a few minutes to familiarize yourself with the directional change each screw has on the finder

Attaching the Hand Control

In order to protect your CPC telescope during shipping, the hand control unit has been packaged along with the other telescope accessories and will need to be plugged in to the drive base of your telescope. The hand control cable has a phone jack style connector that will plug into the designated jack outlet located on the top of the drive base (see figure 3-10). Your telescope also comes with a hand control holder that must be attached to the fork arm. To connect the hand control to the fork arm:

- Locate the hand control holder and slide it down into the slot located on the fork arm (see figure 3-9)
- Push the connector into the jack until it clicks into place.

The hand control can now rest in the holder on the fork arm of the telescope.

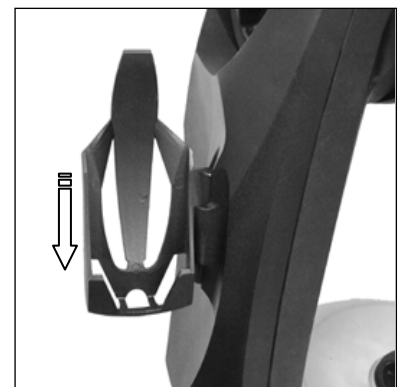

Figure 3-9

Powering the CPC

The CPC can be powered by the supplied 12v car battery adapter or optional power supply (see *Optional Accessories* section in the back of this manual).

1. To power the CPC with the car battery adapter, simply plug the round post into the designated 12v power outlet located on the drive base.
2. Turn on the power to the CPC by flipping the switch, located next to the 12v outlet, to the "On" position.



Figure 3-10

CELESTRON[®] Hand Control

The CPC is controlled by Celestron's NexStar hand controller designed to give you instant access to all the functions the CPC has to offer. With automatic slewing to over 40,000 objects, and common sense menu descriptions, even a beginner can master its variety of features in just a few observing sessions. Below is a brief description of the individual components of the CPC's NexStar hand controller:

1. **Liquid Crystal Display (LCD) Window:** Has a dual-line, 16 character display screen that is backlit for comfortable viewing of telescope information and scrolling text.
2. **Align:** Instructs the CPC to use a selected star or object as an alignment position.
3. **Direction Keys:** Allows complete control of the CPC in any direction. Use the direction keys to move the telescope to the initial alignment stars or for centering objects in the eyepiece.
4. **Catalog Keys:** The NexStar hand control has keys to allow direct access to each of the catalogs in its database. The hand control contains the following catalogs in its database:

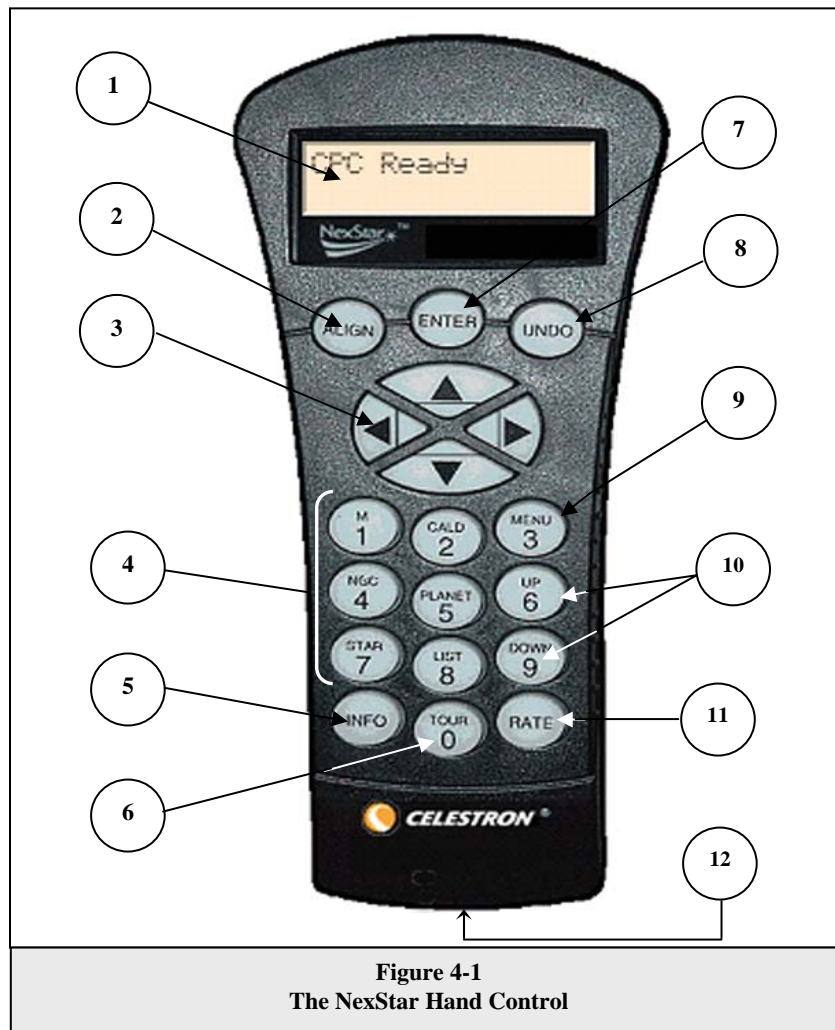

Figure 4-1
The NexStar Hand Control

Messier– Complete list of all Messier objects.

NGC – Complete list of all the deep-sky objects in the Revised New General Catalog.

Caldwell – A combination of the best NGC and IC objects.

Planets - All 8 planets in our Solar System plus the Moon and the Sun.

Stars – A compiled list of the brightest stars from the SAO catalog.

List – For quick access, all of the best and most popular objects in the NexStar database have been broken down into lists based on their type and/or common name:

Named Stars	Common name listing of the brightest stars in the sky.
Named Objects	Alphabetical listing of over 50 of the most popular deep sky objects.
Double Stars	Numeric-alphabetical listing of the most visually stunning double, triple and quadruple stars in the sky.
Variable Stars	Select list of the brightest variable stars with the shortest period of changing magnitude.
Asterisms	A unique list of some of the most recognizable star patterns in the sky.
CCD Objects	A custom list of many interesting galaxy pairs, trios and clusters that are well suited for CCD imaging with the CPC telescope.
IC Objects	A complete list of all the Index Catalog deep-sky objects.
Abell Objects	A complete list of all the Abell Catalog deep-sky objects.

5. **Info:** Displays coordinates and useful information about objects selected from the NexStar database.
6. **Tour:** Activates the tour mode, which seeks out all the best objects for the current date and time, and automatically slews the CPC to those objects.
7. **Enter:** Pressing *Enter* allows you to select any of the CPC functions and accept entered parameters.
8. **Undo:** *Undo* will take you out of the current menu and display the previous level of the menu path. Press *Undo* repeatedly to get back to a main menu or use it to erase data entered by mistake.
9. **Menu:** Displays the many setup and utilities functions such as tracking rate and user defined objects and many others.
10. **Scroll Keys:** Used to scroll up and down within any of the menu lists. A double-arrow will appear on the right side of the LCD when there are sub-menus below the displayed menu. Using these keys will scroll through those sub-menus.
11. **Rate:** Instantly changes the rate of speed of the motors when the direction buttons are pressed.
12. **RS-232 Jack:** Allows you to interface with a computer and control the CPC remotely.

Hand Control Operation

This section describes the basic hand control procedures needed to operate the CPC. These procedures are grouped into three categories: Alignment, Setup and Utilities. The alignment section deals with the initial telescope alignment as well as finding objects in the sky; the setup section discusses changing parameters such as tracking mode, tracking rate and setting filter and slew limits; finally, the last section reviews all of the utilities functions such as PEC, polar alignment and hibernating the telescope.

Alignment Procedures

In order for the CPC to accurately point to objects in the sky, it must first be aligned to known positions (stars) in the sky. With this information, the telescope can create a model of the sky, which it uses to locate any object with known coordinates. There are many ways to align the CPC with the sky depending on what information the user is able to provide: **SkyAlign** use the internal GPS receiver to acquire all the necessary time/site information needed for the CPC to create an accurate model of the sky. Then the user can simply point the telescope to any three bright celestial objects to accurately align the telescope with the sky. **Auto Two-Star Align** will ask the user to choose and center the first alignment star, then the CPC will automatically select and slew to a second star for alignment. **Two-Star Alignment** requires the user to identify and manually slew the telescope to the two alignment stars. **One-Star Align** is the same as Two-Star Align however only requires you to align to one known star. Although not as accurate as the other alignment methods, One-Star Align is the quickest way to find and track bright planets and objects in Altazimuth mode. **Solar System Align** will display a list of visible daytime objects (planets and the moon) available to align the telescope. Finally, **EQ North and EQ South** alignments are designed to assist you in aligning the CPC when polar aligned using an equatorial wedge. Each alignment method is discussed in detail below.

Definition

"Altazimuth" or "Alt-Az" refers to a type of mounting that allows a telescope to move in both altitude (up and down) and azimuth (left and right) with respect to the ground. This is the simplest form of mounting in which the telescope is attached directly to a tripod without the use of an equatorial wedge.

Sky Align

Sky Align must be used with the telescope mounted in altazimuth. With Sky Align, the GPS receiver links with and acquires information from 3 of the orbiting GPS satellites. With this information, the built-in GPS system calculates the scope's location on Earth with an accuracy of a few meters and calculates universal time down to the second. After quickly making

all these calculations and automatically entering the information for you, the user simply needs to aim the telescope to any three bright celestial objects in the sky. Since Sky Align requires no knowledge of the night sky it is not necessary to know the name of the stars that you are aiming. You may even select a planet or the moon. The CPC is then ready to start finding and tracking any of the objects in its 40,000+ object database. Before the telescope is ready to be aligned, it should be set up in an outside location with all accessories (eyepiece, diagonal and finderscope) attached and lens cover removed as described in the Assembly section of the manual. To begin Sky Align:

1. Power on the CPC by flipping the switch located on the control panel of the drive base, to the "on" position. Once turned on the hand control display will say CPC Ready. Press ENTER to choose *Sky Align* or use the UP/Down scroll keys (10) to select a different method of alignment. Pressing the ALIGN key will bypass the other alignment options and the scrolling text and automatically begins *Sky Align*.
2. Once *Sky Align* has been selected, the hand control will display "Enter if OK", "Undo to edit" and "GPS Linking". The bottom line of the LCD will display either the current time or the time when you last used the telescope. The GPS will quickly link up and display the current date, time and location. Additionally you have the option of pressing UNDO and manually updating the time/site information. Press ENTER to accept the time/site information downloaded the GPS.
3. The hand control will display a message reminding you to level the tripod if you already haven't done so. Press ENTER to continue.
4. Use the arrow buttons on the hand control to slew (move) the telescope towards any bright celestial object in the sky. Center the object in the crosshairs of the finderscope and press ENTER.
5. If the finderscope has been properly aligned with the telescope tube, the alignment star should now be visible inside the field of view of the eyepiece. The CPC will ask that you center the bright alignment star in the center of the eyepiece and press the ALIGN button. This will accept the star as the first alignment position. (There is no need to adjust the slewing rate of the motors after each alignment step. The CPC automatically selects the best slewing rate for aligning objects in both the finderscope and the eyepiece).
6. For the second alignment object, choose a bright star or planet as far as possible from the first alignment object. Once again use the arrow button to center the object in the finderscope and press ENTER. Then once centered in the eyepiece press the ALIGN button.
7. Repeat the process for the third alignment star. When the telescope has been aligned to the final stars, the display will read "Match Confirmed". Press UNDO to display the names of the three bright objects you aligned to, or press ENTER to accept these three objects for alignment. You are now ready to find your first object.

A Few Words on GPS:

The CPC uses an on-board GPS to take the guesswork out of aligning your telescope with the sky. Once an alignment method is selected, the CPC automatically initiates the internal GPS module. However, there are a few things you should be aware of in order to get full use of its many capabilities:

- ⊕ **GPS alignment will only work when the telescope is set-up outdoors with an unobstructed view of the sky. If the CPC is set-up in a location that has a limited horizon in any direction it may take longer for the telescope to find and link with the needed satellites.**
- ⊕ **When using the GPS for the first time, it may take 3-5 minutes for the CPC to link-up with its satellites. Once the telescope is successfully linked, leave the telescope powered on for at least 20 minutes. During this time the CPC will download the complete almanac of orbital elements (called the ephemeris) for the orbiting GPS satellites. Once this information is received it will be stored for future alignments.**
- ⊕ **If your CPC is transported over a long distance (say from the northern to the southern hemisphere) it may take as long as one hour to establish a satellite link from its new location. Observers wishing to travel long distances with their telescope are advised to turn on their telescope in advance to allow the GPS to acquire the necessary data.**

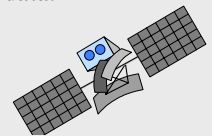

Tips for Using Sky Align

Remember the following alignment guidelines to make using Sky Align as simple and accurate as possible.

- Be sure to level the tripod before you begin alignment. The time/site information along with a level tripod will help the telescope better predict the available bright stars and planets that are above the horizon.
- Remember SkyAlign does not care where the optical tube is pointed at the beginning of the alignment. So to make the alignment process even faster it is acceptable to move the telescope to the first alignment star manually by

loosening both clutches. However the following alignment stars still need to be found and centered using the hand control.

- Remember to select alignment stars that are as far apart in the sky as possible. For best results make sure that the third alignment star does not lie in a straight line between the first two stars. This may result in a failed alignment.
- Don't worry about confusing planets for stars when selecting alignment objects. SkyAlign works with the four brightest planets (Venus, Jupiter, Saturn and Mars) as well as the Moon. In addition to the planets, the hand control has over 80 bright alignment stars to choose from (down to 2.5 magnitude).
- Rarely SkyAlign will not be able to determine what three alignment objects were centered. This sometimes happens when a bright planet or the Moon passes near one of the brighter stars. In situations like these it is best to try to avoid aligning to either object if possible.
- For the best possible pointing accuracy, always center the alignment stars using the same final movements as the direction of the GoTo Approach (by default this will be using the up arrow button and the right arrow button). Approaching the star from this direction when looking through the eyepiece will eliminate much of the backlash between the gears and assure the most accurate alignment possible.

Auto Two-Star Align

As with Sky Align, Auto Two-Star Align downloads all the necessary time/site information from orbiting GPS satellites. Once this information is received, CPC will prompt you to slew the telescope and point at one known star in the sky. The CPC now has all the information it needs to automatically choose a second star that will assure the best possible alignment. Once selected the telescope will automatically slew to that second alignment star to complete the alignment. With the CPC set up outside with all accessories attached and the tripod leveled, follow the steps below to align the telescope:

1. Once the CPC is powered on, Press ENTER to begin alignment.
2. Use the Up and Down scroll keys (10) to select *Auto Two-Star Align* and press ENTER.
3. The hand control will display the last time and location information that was entered or downloaded from the GPS. Use the Up and Down buttons to scroll through the information. Press ENTER to accept the downloaded information or press UNDO to manually edit the information.
4. The display will now prompt you to select a bright star from the displayed list on the hand control. Use Up and Down buttons (6 and 9 on the keypad) to scroll to the desired star and then press ENTER.
5. Use the arrow buttons to slew the telescope to the star you selected. Center the star in the crosshairs of the finderscope and press ENTER. Finally, center the star in the eyepiece and press ALIGN.
6. Based on this information, the CPC will automatically display the most suitable second alignment star that is above the horizon. Press ENTER to automatically slew the telescope to the displayed star. If for some reason you do not wish to select this star (perhaps it is behind a tree or building), you can either:
 - Press the UNDO button to display the next most suitable star for alignment.
 - Use the UP and DOWN scroll buttons to manually select any star you wish from the entire list of available stars.

Once the desired star is displayed press ENTER to automatically slew the telescope to the displayed star. When finished slewing, the display will ask you to use the arrow buttons to align the selected star with the cross hairs in the center of the finderscope. Once centered in the finder, press ENTER. The display will then instruct you to center the star in the field of view of the eyepiece. When the star is centered, press ALIGN to accept this star as your second alignment star. When the telescope has been aligned to both stars the display will read **Alignment Success**, and you are now ready to find your first object.

Two Star Alignment

With the two-star alignment method, the CPC requires the user to know the positions of two bright stars in order to accurately align the telescope with the sky and begin finding objects. Here is an overview of the two-star alignment procedure:

1. Once the CPC is powered on, use the Up and Down scroll keys (10) to select Two-Star Align, and press ENTER.
2. Press ENTER to accept the time/site information displayed on the display, or wait until the telescope has downloaded the information from the GPS satellites.
3. The SELECT STAR 1 message will appear in the top row of the display. Use the Up and Down scroll keys (10) to select the star you wish to use for the first alignment star. Press ENTER.
4. CPC then asks you to center in the eyepiece the alignment star you selected. Use the direction arrow buttons to slew the telescope to the alignment star and carefully center the star in the finderscope. Press ENTER when centered.
5. Then, center the star in the eyepiece and press ALIGN

Helpful Hint

In order to accurately center the alignment star in the eyepiece, you may wish to decrease the slew rate of the motors for fine centering. This is done by pressing the RATE key (11) on the hand controller then selecting the number that corresponds to the speed you desire. (9 = fastest, 1 = slowest).

6. CPC will then ask you to select and center a second alignment star and press the ALIGN key. It is best to choose alignment stars that are a good distance away from one another. Stars that are at least 40° to 60° apart from each other will give you a more accurate alignment than stars that are close to each other.

Once the second star alignment is completed properly, the display will read `Alignment Successful`, and you should hear the tracking motors turn-on and begin to track.

One-Star Align

One-Star Align allows you to download all the same information as you would for the Two-Star Align procedure. However, instead of slewing to two alignment stars for centering and alignment, the CPC uses only one star to model the sky based on the information given. This will allow you to roughly slew to the coordinates of bright objects like the moon and planets and gives the CPC the information needed to track objects in altazimuth in any part of the sky. Quick-Align is not meant to be used to accurately locate small or faint deep-sky objects or to track objects accurately for photography.

To use One-Star Align:

1. Select One-Star Align from the alignment options.
2. Press ENTER to accept the time/site information displayed on the display, or wait until the telescope has downloaded the information from the GPS satellites.
3. The SELECT STAR 1 message will appear in the top row of the display. Use the Up and Down scroll keys (10) to select the star you wish to use for the first alignment star. Press ENTER.
4. CPC then asks you to center in the eyepiece the alignment star you selected. Use the direction arrow buttons to slew the telescope to the alignment star and carefully center the star in the finderscope. Press ENTER when centered.
5. Then, center the star in the eyepiece and press ALIGN
6. Once in position, the CPC will model the sky based on this information and display `Alignment Successful`.

Note: Once a One-Star Alignment has been done, you can use the Re-alignment feature (later in this section) to improve your telescope's pointing accuracy.

Solar System Align

Solar System Align is available in alt-az mode (scope mounted directly on the tripod) and equatorial mode (scope mounted on a wedge). Solar System Align is designed to provide excellent tracking and GoTo performance by using solar system objects (Sun, Moon and planets) to align the telescope with the sky. Solar System Align is a great way to align your telescope for daytime viewing as well as a quick way to align the telescope for night time observing.



Never look directly at the sun with the naked eye or with a telescope (unless you have the proper solar filter). Permanent and irreversible eye damage may result.

1. Select Solar System Align from the alignment options.
2. Press ENTER to accept the time/site information displayed on the display, or wait until the telescope has downloaded the information from the GPS satellites.
3. The SELECT OBJECT message will appear in the top row of the display. Use the Up and Down scroll keys (10) to select the daytime object (planet, moon or sun) you wish to align. Press ENTER.
4. CPC then asks you to center in the eyepiece the alignment object you selected. Use the direction arrow buttons to slew the telescope to the alignment object and carefully center it in the finderscope. Press ENTER when centered.
5. Then, center the object in the eyepiece and press ALIGN.

Once in position, the CPC will model the sky based on this information and display **Alignment Successful**.

Tips for Using Solar System Align

- For safety purposes, the Sun will not be displayed in any of the hand control's customer object lists unless it is enabled from the Utilities Menu. To allow the Sun to be displayed on the hand control, do the following:
 1. Press the UNDO button until the display reads "CPC Ready"
 2. Press the MENU button and use the Up and Down keys to select the *Utilities menu*. Press ENTER.
 3. Use the UP and Down keys to select *Sun Menu* and press ENTER.
 4. Press ENTER again to allow the Sun to appear on the hand control display.

The Sun can be removed from the display by using the same procedure as above.

- To improve the telescope pointing accuracy, you can use the Re-Align feature as described below.

EQ North / EQ South Alignment

EQ North and EQ South Alignments assist the user in aligning the telescope when polar aligned on an optional equatorial wedge. Similar to the Altazimuth alignments described earlier, the EQ alignments gives you the choice of performing an AutoAlign, Two-Star alignment, One-Star alignment or Solar System alignment.

EQ AutoAlign

The EQ AutoAlign uses all the same time/site information as the Alt-Az alignments, however it also requires you to position the tube so that the altitude index markers are aligned (see figure 4-2), and then rotate the telescope base until the tube is pointed towards the Meridian (see figure 4-3). Based on this information the CPC will automatically slew to two selected alignment stars to be centered and aligned. To use EQ Auto-Align:

1. Select EQ North or South Align from the alignment options and press ENTER
2. Press ENTER to accept the time/site information displayed on the display, or wait until the telescope has downloaded the information from the GPS satellites.
3. Select EQ AutoAlign method and press ENTER
4. Use the up and down arrow buttons to move the telescope tube upwards until the altitude index markers are aligned. The altitude index markers are located at the top of the fork arm. See figure 4-2.
5. Use the left and right arrow buttons to move the telescope base until the fork arms are horizontally parallel and the tube is pointing towards the Meridian.
6. Based on this information, the CPC will automatically display the most suitable alignment stars that are above the horizon. Press ENTER to automatically slew the telescope to the displayed star. If for some reason you do not wish to select one of these stars (perhaps it is behind a tree or building), you can either:
 - Press the UNDO button to display the next most suitable star for alignment.
 - Use the UP and DOWN scroll buttons to manually select any star you wish from the entire list of available stars.
7. CPC then asks you to center in the eyepiece the alignment object you selected. Use the direction arrow buttons to slew the telescope to the alignment object and carefully center it in the finderscope. Press ENTER when centered.
8. Then, center the object in the eyepiece and press ALIGN.
9. Once you press the ALIGN button the telescope will automatically slew to a second alignment star. Repeat steps 6 and 7 to complete alignment.

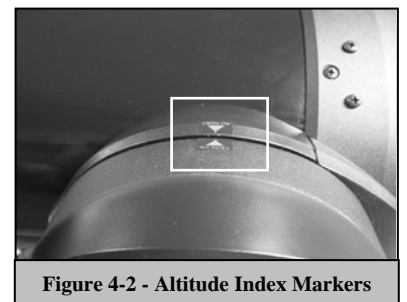

Figure 4-2 - Altitude Index Markers

EQ Two-Star Align

The EQ Two-Star Align follows most of the same steps as the Alt-Az Two-Star Align. This alignment method does not require the user to align the altitude index markers or point towards the Meridian, but it does require the user to locate and align the telescope on two bright stars. When selecting alignment stars it is best to choose stars that, a) have a large separation in azimuth and b) both are either positive or negative in declination. Following these two guidelines will result in a more accurate EQ Two-Star alignment.

EQ One-Star Align

EQ One-Star Align operates much the same way as EQ Two-Star Align however it only relies on the alignment of one star to align the telescope. To use EQ One-Star Align follow steps 1 through 7 under the EQ Two-Star Align section.

EQ Solar System Align

This alignment method allows you use only one solar system object to equatorially align the telescope for daytime use. To align your telescope using a solar system object follow steps 1 through 7 under the EQ Two-Star Align section.

CPC Re-Alignment

The CPC has a re-alignment feature which allows you to replace either of the original alignment stars with a new star or celestial object. This can be useful in several situations:

- If you are observing over a period of a few hours, you may notice that your original alignment stars have drifted towards the west considerably. (Remember that the stars are moving at a rate of 15° every hour). Aligning on a new star that is in the eastern part of the sky will improve your pointing accuracy, especially on objects in that part of the sky.
- If you have aligned your telescope using the One-Star or Solar System alignment method, you can use *re-align* to align to additional objects in the sky. This will improve the pointing accuracy of your telescope without having to re-enter addition information.

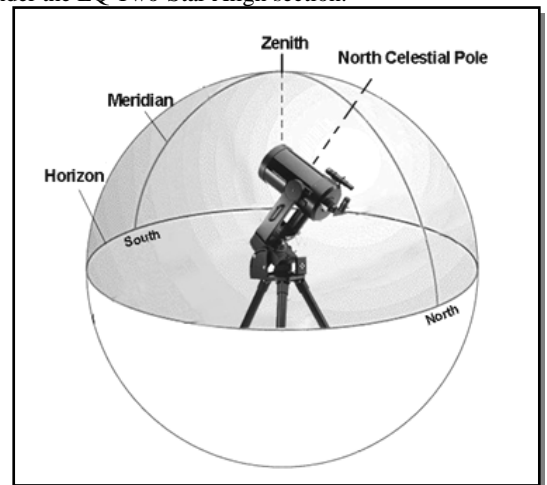

Figure 4-3

The Meridian is an imaginary line in the sky that starts at the North celestial pole and ends at the South celestial pole and passes through the zenith. If you are facing South, the meridian starts from your Southern horizon and passes directly overhead to the North celestial pole.

To replace an existing alignment star with a new alignment star:

1. Select the desired star (or object) from the database and slew to it.
2. Carefully center the object in the eyepiece.
3. Once centered, press the UNDO button until you are at the main menu.
4. With CPC Ready displayed, press the ALIGN key on the hand control.
5. The display will then ask you which alignment star you want to replace. Use the UP and Down scroll keys to select the alignment star to be replaced. It is usually best to replace the star closest to the new object. This will space out your alignment stars across the sky. If you have used one of the single object alignment methods then it is always best to replace the object that is “unassigned” with an actual object.
6. Press ALIGN to make the change.

Selecting an Object

Helpful Hint

Now that the telescope is properly aligned, you can choose an object from any of the catalogs in the CPC's extensive database. The hand control has a key (4) designated for each of the catalogs in its database. There are two ways to select objects from the database: scrolling through the named object lists and entering object numbers.

Pressing the LIST key on the hand control will access all objects in the database that have common names or types. Each list is broken down into the following categories: Named Stars, Named Object, Double Stars, Variable Stars, Asterisms and

CCD Objects. Selecting any one of these catalogs will display a numeric-alphabetical listing of the objects under that list. Pressing the Up and Down keys (10) allows you to scroll through the catalog to the desired object.

When scrolling through a long list of objects, holding down either the Up or Down key will allow you to scroll through the catalog at a rapid speed.

Pressing any of the other catalog keys (M, CALD, NGC, or STAR) will display a blinking cursor below the name of the catalog chosen. Use the numeric key pad to enter the number of any object within these standardized catalogs. For example, to find the Orion Nebula, press the "M" key and enter "042".

When entering the number for a SAO star, you are only required to enter the first four digits of the objects six digit SAO number. Once the first four digits are entered, the hand control will automatically list all the available SAO objects beginning with those numbers. This allows you to scroll through only the SAO stars in the database. For example, in searching for the SAO star 40186 (Capella), the first four digits would be "0401". Entering this number will display the closest match from the SAO stars available in the database. From there you can scroll down the list and select the desired object.

Slewing to an Object

Once the desired object is displayed on the hand control screen, choose from the following options:

- **Press the INFO Key.** This will give you useful information about the selected object such as R.A. and declination, magnitude size and text information for many of the most popular objects.
- **Press the ENTER Key.** This will automatically slew the telescope to the coordinates of the object.

Caution: Never slew the telescope when someone is looking into the eyepiece. The telescope can move at fast slew speeds and may hit an observer in the eye.

If you manually enter an object that is below the horizon, CPC will notify you by displaying a message reminding you that you have selected an object outside of your slew limits (see Slew Limits in the Scope Setup section of the manual). Press UNDO to go back and select a new object. Press ENTER to ignore the message and continue the slew.

Object information can be obtained without having to do a star alignment. After the telescope is powered on, pressing any of the catalog keys allows you to scroll through object lists or enter catalog numbers and view the information about the object as described above.

Finding Planets

The CPC can locate all 8 of our solar system planets plus the Sun and Moon. However, the hand control will only display the solar system objects that are above the horizon (or within its filter limits). To locate the planets, press the PLANET key on the hand control. The hand control will display all solar system objects that are above the horizon:

- Use the **Up and Down** keys to select the planet that you wish to observe.
- Press **INFO** to access information on the displayed planet.
- Press **ENTER** to slew to the displayed planet.

To allow the Sun to be displayed as an option in the database, see *Sun Menu* in the Utilities section of the manual.

Tour Mode

The CPC includes a tour feature which automatically allows the user to choose from a list of interesting objects based on the date and time in which you are observing. The automatic tour will display only those objects that are within your set filter limits (see *Filter Limits* in the *Setup Procedures* section of the manual). To activate the Tour mode, press the TOUR key (6) on the hand control. The CPC will display the best objects to observe that are currently in the sky.

- To see information and data about the displayed object, press the INFO key.
- To slew to the object displayed, press ENTER.
- To see the next tour object, press the Up key.

Constellation Tour

In addition to the Tour Mode, the CPC telescope has a Constellation Tour that allows the user to take a tour of all the best objects within a particular constellation. Selecting *Constellation* from the LIST menu will display all the constellation names that are above the user defined horizon (filter limits). Once a constellation is selected, you can choose from any of the database object catalogs to produce a list of all the available objects in that constellation.

- To see information and data about the displayed object, press the INFO key.
- To slew to the object displayed, press ENTER.
- To see the next tour object, press the Up key.

Direction Buttons

The CPC has four direction buttons (3) in the center of the hand control which control the telescope's motion in altitude (up and down) and azimuth (left and right). The telescope can be controlled at nine different speed rates.

Rate Button

Pressing the RATE key (11) allows you to instantly change the speed rate of the motors from high speed slew rate to precise guiding rate or anywhere in between. Each rate corresponds to a number on the hand controller key pad. The number 9 is the fastest rate (3° per second, depending on power source) and is used for slewing between objects and locating alignment stars. The number 1 on the hand control is the slowest rate (.5x sidereal) and can be used for accurate centering of objects in the eyepiece and photographic guiding. To change the speed rate of the motors:

- Press the RATE key on the hand control. The LCD will display the current speed rate.
- Press the number on the hand control that corresponds to the desired speed. The number will appear in the upper-right corner of the LCD display to indicate that the rate has been changed.

The hand control has a "double button" feature that allows you to instantly speed up the motors without having to choose a speed rate. To use this feature, simply press the arrow button that corresponds to the direction that you want to move the telescope. While holding that button down, press the opposite directional button. This will increase the slew rate to the maximum slew rate.

When pressing the Up and Down arrow buttons in the slower slew rates (6 and lower) the motors will move the telescope in the opposite direction than the faster slew rates (7 thru 9). This is done so that an object will move in the appropriate direction when looking into the eyepiece (i.e. pressing the Up arrow button will move the star up in the field of view of the eyepiece). However, if any of the slower slew rates (rate 6 and below) are used to center an object in the finderscope, you may need to press the opposite directional button to make the telescope move in the correct direction.

<i>1 = .5x*</i>	<i>6 = 64x</i>
<i>2 = 1x (sidereal)*</i>	<i>7 = .5° / sec</i>
<i>3 = 4x</i>	<i>8 = 2° / sec</i>
<i>4 = 8x</i>	<i>9 = 3° / sec</i>
<i>5 = 16x</i>	
Nine available slew speeds	

*Rate 1 and 2 are photographic guide rates and are meant to be used when the telescope is set up on a wedge in equatorial mode. These rates can be used while set up in altazimuth, however the actual speed rate may differ slightly.

Setup Procedures

The CPC contains many user defined setup functions designed to give the user control over the telescope's many advanced features. All of the setup and utility features can be accessed by pressing the MENU key and scrolling through the options:

Tracking Mode This allows you to change the way the telescope tracks depending on the type of mount being used to support the telescope. The CPC has three different tracking modes:

Alt-Az This is the default tracking rate and is used when the telescope is placed on

a flat surface or tripod without the use of an equatorial wedge. The telescope must be aligned with two stars before it can track in altazimuth (Alt-Az).

- EQ North** Used to track the sky when the telescope is polar aligned using an equatorial wedge in the Northern Hemisphere.
- EQ South** Used to track the sky when the telescope is polar aligned using an equatorial wedge in the Southern Hemisphere.
- Off** When using the telescope for terrestrial (land) observation, the tracking can be turned off so that the telescope never moves.

Tracking Rate In addition to being able to move the telescope with the hand control buttons, the CPC will continually track a celestial object as it moves across the night sky. The tracking rate can be changed depending on what type of object is being observed:

- Sidereal** This rate compensates for the rotation of the Earth by moving the telescope at the same rate as the rotation of the Earth, but in the opposite direction. When the telescope is polar aligned, this can be accomplished by moving the telescope in right ascension only. When mounted in Alt-Az mode, the telescope must make corrections in both R.A. and declination.
- Lunar** Used for tracking the moon when observing the lunar landscape.
- Solar** Used for tracking the Sun when solar observing.

View Time-Site - Displays the current time and longitude/latitude downloaded from the GPS receiver. It will also display other relevant time-site information like time zone, daylight saving and local sidereal time. Local sidereal time (LST) is useful for knowing the right ascension of celestial objects that are located on the meridian at that time. *View Time-Site* will always display the last saved time and location entered while it is linking with the GPS. Once current information has been received, it will update the displayed information. If GPS is switched off, the hand control will only display the last saved time and location.

User Defined Objects - The CPC can store up to 400 different user defined objects in its memory. The objects can be daytime land objects or an interesting celestial object that you discover that is not included in the regular database. There are several ways to save an object to memory depending on what type of object it is:

Save Sky Object: The CPC stores celestial objects to its database by saving its right ascension and declination in the sky. This way the same object can be found each time the telescope is aligned. Once a desired object is centered in the eyepiece, simply scroll to the "Save Sky Obj" command and press ENTER. The display will ask you to enter a number between 1-200 to identify the object. Press ENTER again to save this object to the database.

Save Land Object: The CPC can also be used as a spotting scope on terrestrial objects. Fixed land objects can be stored by saving their altitude and azimuth relative to the location of the telescope at the time of observing. Since these objects are relative to the location of the telescope, they are only valid for that exact location. To save land objects, once again center the desired object in the eyepiece. Scroll down to the "Save Land Obj" command and press ENTER. The display will ask you to enter a number between 1-200 to identify the object. Press ENTER again to save this object to the database.

Save Database (Db) Object:

This feature allows you to create your own custom tour of database objects by allowing you to record the current position of the telescope and save the name of the object by selecting it from any one of the database catalogs. These objects then can be accessed by selecting *GoTo Sky Object*.

Enter R.A. - Dec: You can also store a specific set of coordinates for an object just by entering the R.A. and declination for that object. Scroll to the "Enter RA-DEC " command and press ENTER. The display will then ask you to enter first the R.A. and then the declination of the desired object.

GoTo Object: To go to any of the user defined objects stored in the database, scroll down to either GoTo Sky Obj or GoTo Land Obj and enter the number of the object you wish to select and press ENTER. CPC will automatically retrieve and display the coordinates before slewing to the object.

To replace the contents of any of the user defined objects, simply save a new object using one of the existing identification numbers; CPC will replace the previous user defined object with the current one.

Get RA/DEC - Displays the right ascension and declination for the current position of the telescope.

Goto R.A/ Dec - Allows you to input a specific R.A. and declination and slew to it.

Identify

Identify Mode will search any of the CPC database catalogs or lists and display the name and offset distances to the nearest matching objects. This feature can serve two purposes. First, it can be used to identify an unknown object in the field of view of your eyepiece. Additionally, *Identify Mode* can be used to find other celestial objects that are close to the objects you are currently observing. For example, if your telescope is pointed at the brightest star in the constellation Lyra, choosing *Identify* and then searching the *Named Star* catalog will no doubt return the star Vega as the star you are observing. However, by selecting *Identify* and searching by the *Named Object* or *Messier* catalogs, the hand control will let you know that the Ring Nebula (M57) is approximately 6° from your current position. Searching the Double Star catalog will reveal that Epsilon Lyrae is only 1° away from Vega. To use the *Identify* feature:

- Press the Menu button and select the Identify option.
- Use the Up/Down scroll keys to select the catalog that you would like to search.
- Press ENTER to begin the search.

Note: Some of the databases contain thousands of objects, and can therefore take a minute or two to return the closest object.

Precise GoTo

The CPC has a precise goto function that can assist in finding extremely faint objects and centering objects closer to the center of the field of view for astrophotography and CCD imaging. Precise Goto automatically searches out the closest bright star to the desired object and asks the user to carefully center it in the eyepiece. The hand control then calculates the small difference between its goto position and its centered position. Using this offset, the telescope will then slew to the desired object with enhanced accuracy. To use Precise Goto:

1. Press the MENU button and use the Up/Down keys to select *Precise Goto*.
 - Choose *Database* to select the object that you want to observe from any of the database catalogs listed
 - Choose *RA/DEC* to enter a set of celestial coordinates that you wish to slew to.
2. Once the desired object is selected, the hand control will search out and display the closest bright star to your desired object. Press ENTER to slew to the bright alignment star.
3. Use the direction buttons to carefully center the alignment star in the eyepiece.

Press ENTER to slew to the desired object.



**Helpful
Hint**

To store a set of coordinates (R.A./Dec) permanently into the CPC database, save it as a *User Defined Object* as described above.

Scope Setup Features

Setup Time-Site - Allows the user to customize the CPC display by changing time and location parameters (such as time zone and daylight savings).

Anti-backlash – All mechanical gears have a certain amount of backlash or play between the gears. This play is evident by how long it takes for a star to move in the eyepiece when the hand control arrow buttons are pressed (especially when changing directions). The CPC's anti-backlash features allows the user to compensate for backlash by inputting a value which quickly rewinds the motors just enough to eliminate the play between gears. The amount of compensation needed depends on the slewing rate selected; the slower the slewing rate the longer it will take for the star to appear to move in the eyepiece. There are two values for each axis, positive and negative. Positive is the amount of compensation applied when you press the button, in order to get the gears moving quickly without a long pause. Negative is the amount of compensation applied when you release the button, winding the motors back in the other direction to resume tracking. You will need to experiment with different values (from 0-99); a value between 20 and 50 is usually best for most visual observing, whereas a higher value may be necessary for photographic guiding. Positive backlash compensation is applied when the mount changes its direction of movement from backwards to forwards. Similarly, negative backlash compensation is applied when the mount changes its direction of movement from forwards to backwards. When tracking is enabled, the mount will be moving in one or both axes in either the positive or negative direction, so backlash compensation will always be applied when a direction button is released and the direction moved is opposite to the direction of travel.

To set the anti-backlash value, scroll down to the *anti-backlash* option and press ENTER. While viewing an object in the eyepiece, observe the responsiveness of each of the four arrow buttons. Note which directions you see a pause in the star movement after the button has been pressed. Working one axis at a time, adjust the backlash settings high enough to cause immediate movement without resulting in a pronounced jump when pressing or releasing the button. Now, enter the same values for both positive and negative directions. If you notice a jump when releasing the button, but setting the values lower results in a pause when pressing the button, go with the higher value for positive, but use a lower value for negative. CPC will remember these values and use them each time it is turned on until they are changed.

Slew Limits – Sets the limits in altitude that the telescope can slew without displaying a warning message. By default the slew limits are set to 0° to 90° and will only display a warning message if an object is below the horizon. However, the slew limits can be customized depending on your needs. For example, if you have certain photographic accessories attached to your telescope preventing it from pointing straight-up, you can set the maximum altitude limit to read 80°, thus preventing the telescope from pointing to any objects that are greater than 80° in altitude without warning.

Helpful Hint

Slew limits are applied relative to the base of the mount not the actual horizon. So when setting the slew limits when using the telescope on an equatorial wedge remember that a minimum slew limit of 0° would prevent the telescope from slewing down past the celestial equator not the horizon. To set the slew limit so that the telescope will slew to the horizon while on a wedge, you must set the minimum slew limit to equal your latitude minus 90°.

Filter Limits – When an alignment is complete, the CPC automatically knows which celestial objects are above the horizon. As a result, when scrolling through the database lists (or selecting the Tour function), the CPC hand control will display only those objects that are known to be above the horizon when you are observing. You can customize the object database by selecting altitude limits that are appropriate for your location and situation. For example, if you are observing from a mountainous location where the horizon is partially obscured, you can set your minimum altitude limit to read +20°. This will make sure that the hand control only displays objects that are higher in altitude than 20°. If you manually enter an object that is below the horizon using the numeric keypad, the hand control will display a warning message before slewing to the object.

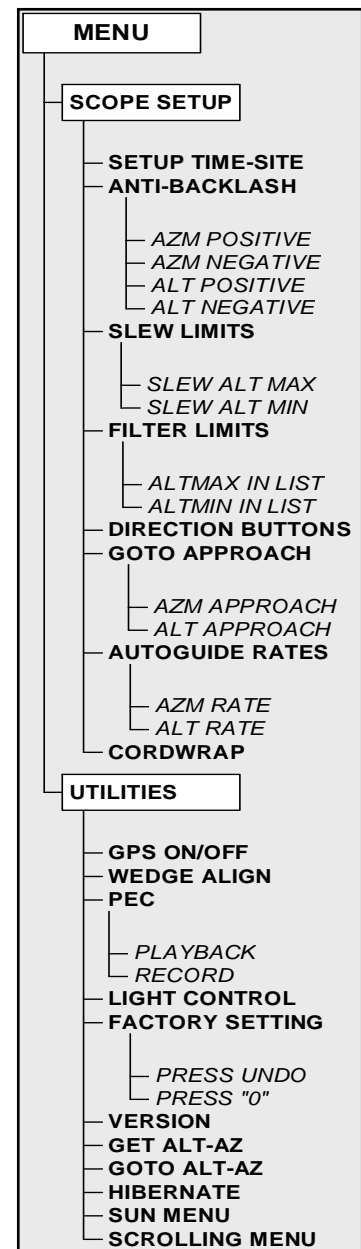

**Observing
Tip!**

If you want to explore the entire object database, set the maximum altitude limit to 90° and the minimum limit to -90° . This will display every object in the database lists regardless of whether it is visible in the sky from your location.

Direction Buttons –The direction a star moves in the eyepiece varies depending on the accessories being used. This can create confusion when guiding on a star using an off-axis guider versus a straight through guide scope. To compensate for this, the direction of the drive control keys can be changed. To reverse the button logic of the hand control, press the MENU button and select *Direction Buttons* from the Utilities menu. Use the Up/Down arrow keys (10) to select either the azimuth (left and right) or altitude (up and down) button direction and press ENTER. Pressing ENTER again will reverse the direction of the hand control buttons from their current state. Direction Buttons will only change the eyepiece rates (rate 1-6) and will not affect the slew rates (rate 7-9).

Goto Approach - lets the user define the direction that the telescope will approach when slewing to an object. This allows the user the ability to minimize the effects of backlash. For example, if your telescope is back heavy from using heavy optical or photographic accessories attached to the back, you would want to set your altitude approach to the negative direction. This would ensure that the telescope always approaches an object from the opposite direction as the load pulling on the scope. Similarly, if using the CPC polar aligned on a wedge, you would want to set the azimuth approach to the direction that allows the scope to compensate for different load level on the motors and gears when pointing in different parts of the sky.

To change the goto approach direction, simply choose *Goto Approach* from the *Scope Setup* menu, select either Altitude or Azimuth approach, choose positive or negative and press Enter.

Autoguide Rate – Allows the user to set an autoguide rate as a percentage of sidereal rate. This is helpful when calibrating your telescope to a CCD autoguider for long exposure photography.

Cordwrap - – Cord wrap safeguards against the telescope slewing more than 360° in azimuth and wrapping accessory cables around the base of the telescope. This is useful when autoguiding or any time that cables are plugged into the base of the telescope. By default, the cord wrap feature is turned off when the telescope is aligned in altazimuth and turn on when aligned on a wedge.

Utility Features

Scrolling through the MENU (9) options will also provide access to several advanced utility functions within the CPC such as; Compass Calibration, Periodic Error Correction, Hibernate as well as many others.

GPS On/Off - Allows you to turn off the GPS module. When aligning the telescope, the CPC still receives information, such as current time, from the GPS. If you want to use the CPC database to find the coordinates of a celestial object for a future date you would need to turn the GPS module off in order to manually enter a date and time other than the present.

Wedge Align – The CPC has two equatorial alignment modes (one for the northern hemisphere and one for the southern) that will help you to polar align your telescope when using an optional equatorial wedge. See the *Astronomy Basics* section of the manual for more information on the *Wedge Align* feature.

Periodic Error Correction (PEC) - PEC is designed to improve photographic quality by reducing the amplitude of the worm gear errors and improving the tracking accuracy of the drive. This feature is for advanced astrophotography and is used when your telescope is polar aligned with the optional equatorial wedge. For more information on using PEC, see the section on “Celestial Photography”.

Light Control – This feature allows you to turn off both the red key pad light and LCD display for daytime use to conserve power and to help preserve your night vision.

Factory Setting – Returns the CPC hand control to its original factory setting. Parameters such as backlash compensation values, initial date and time, longitude/latitude along with slew and filter limits will be reset. However, stored parameters such as PEC and user defined objects will remain saved even when *Factory Settings* is selected. The hand control will ask you to press the "0" key before returning to the factory default setting.

Version - Selecting this option will allow you to see the current version number of the hand control and motor control software. The first set of numbers indicate the hand control software version. For the motor control, the hand control will display two sets of numbers; the first numbers are for azimuth and the second set are for altitude.

Get Alt-Az - Displays the relative altitude and azimuth for the current position of the telescope.

Goto Alt-Az - Allows you to enter a specific altitude and azimuth position and slew to it.

Hibernate - Hibernate allows the CPC to be completely powered down and still retain its alignment when turned back on. This not only saves power, but is ideal for those that have their telescopes permanently mounted or leave their telescope in one location for long periods of time. To place your telescope in Hibernate mode:

1. Select Hibernate from the Utility Menu.
2. Move the telescope to a desire position and press ENTER.
3. Power off the telescope. Remember to never move your telescope manually while in Hibernate mode.

Once the telescope is powered on again the display will read Wake Up. After pressing Enter you have the option of scrolling through the time/site information to confirm the current setting. Press ENTER to wake up the telescope.

**Helpful
Hint**

Pressing UNDO at the Wake Up screen allows you to explore many of the features of the hand control without waking the telescope up from hibernate mode. To wake up the telescope after UNDO has been pressed, select Hibernate from the Utility menu and press ENTER. Do not use the direction buttons to move the telescope while in hibernate mode.

Sun Menu

For safety purposes the Sun will not be displayed as a database object unless it is first enabled. To enable the Sun, go to the *Sun Menu* and press ENTER. The Sun will now be displayed in the Planets catalog as can be used as an alignment object when using the Solar System Alignment method. To remove the Sun from displaying on the hand control, once again select the Sun Menu from the Utilities Menu and press ENTER.

Scrolling Menu

This menus allows you to change the rate of speed that the text scrolls across the hand control display.

- Press the Up (number 6) button to increase the speed of the text.
- Press the Down (number 9) button to decrease the speed of the text.

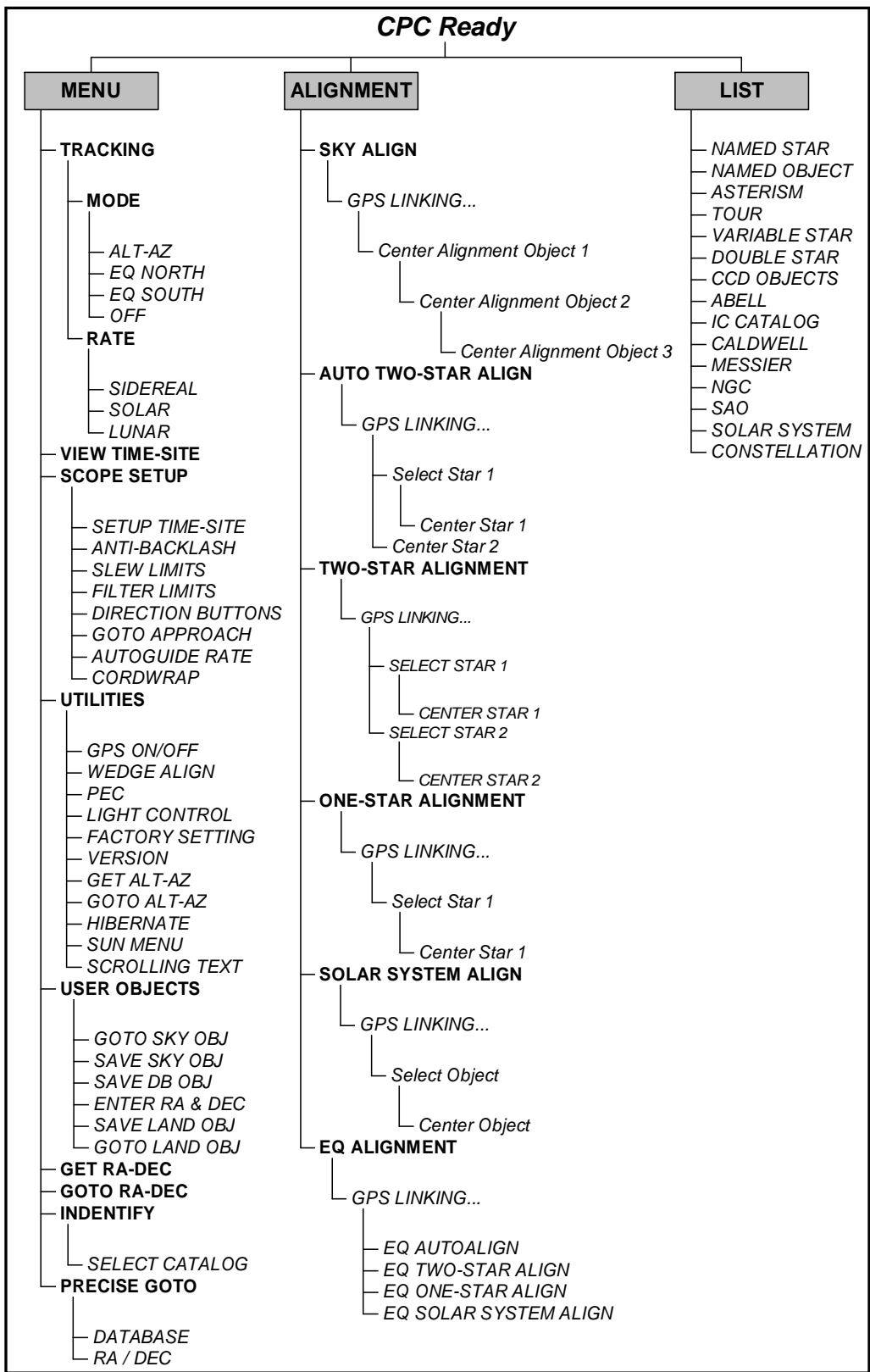

CPC Menu Tree:
The following figure is a menu tree showing the sub-menus associated with the primary command functions

CELESTRON Telescope Basics

A telescope is an instrument that collects and focuses light. The nature of the optical design determines how the light is focused. Some telescopes, known as refractors, use lenses. Other telescopes, known as reflectors, use mirrors. The Schmidt-Cassegrain optical system (or Schmidt-Cass for short) uses a combination of mirrors and lenses and is referred to as a compound or catadioptric telescope. This unique design offers large-diameter optics while maintaining very short tube lengths, making them extremely portable. The Schmidt-Cassegrain system consists of a zero power corrector plate, a spherical primary mirror, and a secondary mirror. Once light rays enter the optical system, they travel the length of the optical tube three times.

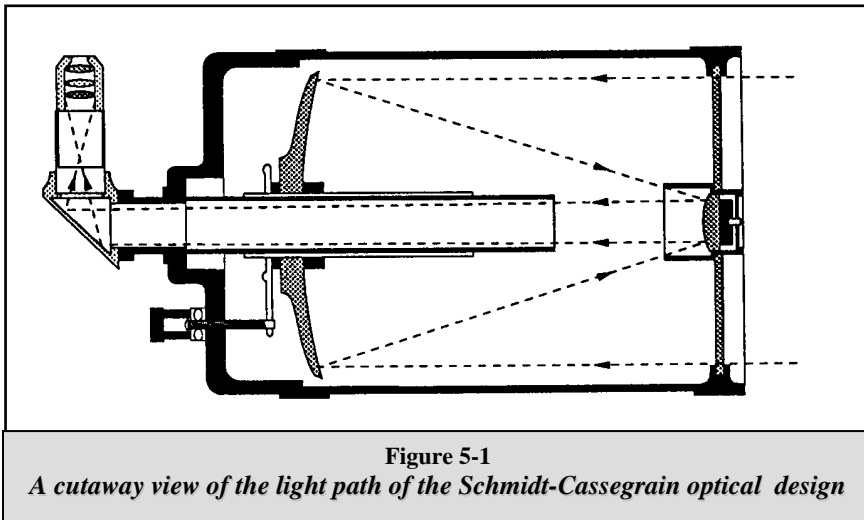

The optics of the CPC have Starbright coatings - enhanced multi-layer coatings on the primary and secondary mirrors for increased reflectivity and a fully coated corrector for the finest anti-reflection characteristics.

Inside the optical tube, a black tube extends out from the center hole in the primary mirror. This is the primary baffle tube and it prevents stray light from passing through to the eyepiece or camera.

Image Orientation

The image orientation changes depending on how the eyepiece is inserted into the telescope. When using the star diagonal, the image is right-side-up, but reversed from left-to-right (i.e., mirror image). If inserting the eyepiece directly into the visual back (i.e., without the star diagonal), the image is upside-down and reversed from left-to-right (i.e., inverted). This is normal for the Schmidt-Cassegrain design.

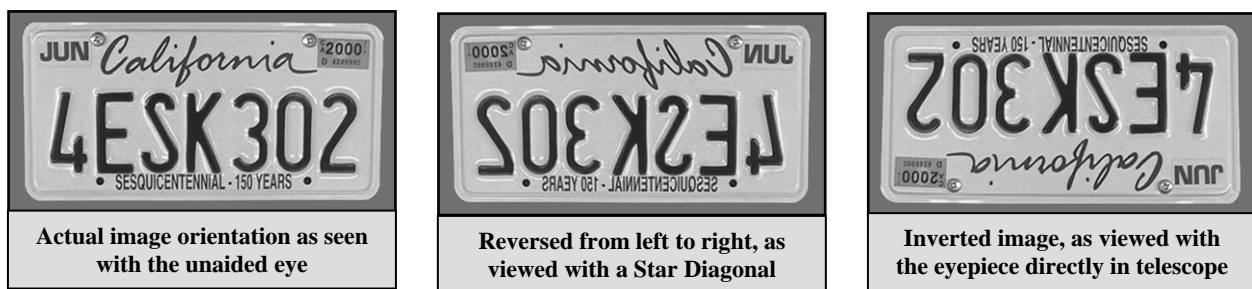

Figure 5-2

Focusing

The CPC's focusing mechanism controls the primary mirror which is mounted on a ring that slides back and forth on the primary baffle tube. The focusing knob, which moves the primary mirror, is on the rear cell of the telescope just below the star diagonal and eyepiece. Turn the focusing knob until the image is sharp. If the knob will not turn, it has reached the end of its travel on the focusing mechanism. Turn the knob in the opposite direction until the image is sharp. Once an image is in focus, turn the knob clockwise to focus on a closer object and counterclockwise for a more distant object. A single turn of the focusing knob moves

the primary mirror only slightly. Therefore, it will take many turns (about 30) to go from close focus (approximately 60 feet) to infinity.

For astronomical viewing, out of focus star images are very diffuse, making them difficult to see. If you turn the focus knob too quickly, you can go right through focus without seeing the image. To avoid this problem, your first astronomical target should be a bright object (like the Moon or a planet) so that the image is visible even when out of focus. Critical focusing is best accomplished when the focusing knob is turned in such a manner that the mirror moves against the pull of gravity. In doing so, any mirror shift is minimized. For astronomical observing, both visually and photographically, this is done by turning the focus knob counterclockwise.

Calculating Magnification

You can change the power of your telescope just by changing the eyepiece (ocular). To determine the magnification of your telescope, simply divide the focal length of the telescope by the focal length of the eyepiece used. In equation format, the formula looks like this:

$$\text{Magnification} = \frac{\text{Focal Length of Telescope (mm)}}{\text{Focal Length of Eyepiece (mm)}}$$

Let's say, for example, you are using the 40mm Plossl eyepiece. To determine the magnification you simply divide the focal length of your telescope (the CPC 8 for example has a focal length of 2032mm) by the focal length of the eyepiece, 40mm. Dividing 2032 by 40 yields a magnification of 51 power.

Although the power is variable, each instrument under average skies has a limit to the highest useful magnification. The general rule is that 60 power can be used for every inch of aperture. For example, the CPC 8 is 8 inches in diameter. Multiplying 8 by 60 gives a maximum useful magnification of 480 power. Although this is the maximum useful magnification, most observing is done in the range of 20 to 35 power for every inch of aperture which is 160 to 280 times for the CPC 8 telescope.

Determining Field of View

Determining the field of view is important if you want to get an idea of the angular size of the object you are observing. To calculate the actual field of view, divide the apparent field of the eyepiece (supplied by the eyepiece manufacturer) by the magnification. In equation format, the formula looks like this:

$$\text{True Field} = \frac{\text{Apparent Field of Eyepiece}}{\text{Magnification}}$$

As you can see, before determining the field of view, you must calculate the magnification. Using the example in the previous section, we can determine the field of view using the same 40mm eyepiece. The 40mm Plossl eyepiece has an apparent field of view of 46°. Divide the 46° by the magnification, which is 51 power. This yields an actual field of .9°, or almost a full degree.

To convert degrees to feet at 1,000 yards, which is more useful for terrestrial observing, simply multiply by 52.5. Continuing with our example, multiply the angular field .9° by 52.5. This produces a linear field width of 47 feet at a distance of one thousand yards. The apparent field of each eyepiece that Celestron manufactures is found in the Celestron Accessory Catalog (#93685).

General Observing Hints

When working with any optical instrument, there are a few things to remember to ensure you get the best possible image.

- Never look through window glass. Glass found in household windows is optically imperfect, and as a result, may vary in thickness from one part of a window to the next. This inconsistency can and will affect the ability to focus your telescope. In most cases you will not be able to achieve a truly sharp image, while in some cases, you may actually see a double image.

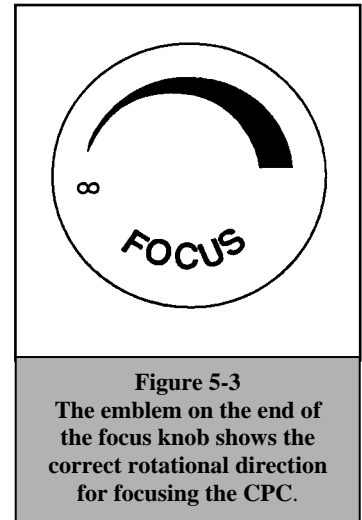

Figure 5-3
The emblem on the end of the focus knob shows the correct rotational direction for focusing the CPC.

- Never look across or over objects that are producing heat waves. This includes asphalt parking lots on hot summer days or building rooftops.
- Hazy skies, fog, and mist can also make it difficult to focus when viewing terrestrially. The amount of detail seen under these conditions is greatly reduced. Also, when photographing under these conditions, the processed film may come out a little grainier than normal with lower contrast and underexposed.
- If you wear corrective lenses (specifically glasses), you may want to remove them when observing with an eyepiece attached to the telescope. When using a camera, however, you should always wear corrective lenses to ensure the sharpest possible focus. If you have astigmatism, corrective lenses must be worn at all times.

Astronomy Basics

Up to this point, this manual covered the assembly and basic operation of your CPC telescope. However, to understand your telescope more thoroughly, you need to know a little about the night sky. This section deals with observational astronomy in general and includes information on the night sky and polar alignment.

The Celestial Coordinate System

To help find objects in the sky, astronomers use a celestial coordinate system that is similar to our geographical coordinate system here on Earth. The celestial coordinate system has poles, lines of longitude and latitude, and an equator. For the most part, these remain fixed against the background stars.

The celestial equator runs 360 degrees around the Earth and separates the northern celestial hemisphere from the southern. Like the Earth's equator, it bears a reading of zero degrees. On Earth this would be latitude. However, in the sky this is referred to as declination, or DEC for short. Lines of declination are named for their angular distance above and below the celestial equator. The lines are broken down into degrees, minutes of arc, and seconds of arc. Declination readings south of the equator carry a minus sign (-) in front of the coordinate and those north of the celestial equator are either blank (i.e., no designation) or preceded by a plus sign (+).

The celestial equivalent of longitude is called Right Ascension, or R.A. for short. Like the Earth's lines of longitude, they run from pole to pole and are evenly spaced 15 degrees apart. Although the longitude lines are separated by an angular distance, they are also a measure of time. Each line of longitude is one hour apart from the next. Since the Earth rotates once every 24 hours, there are 24 lines total. As a result, the R.A. coordinates are marked off in units of time. It begins with an arbitrary point in the constellation of Pisces designated as 0 hours, 0 minutes, 0 seconds. All other points are designated by how far (i.e., how long) they lag behind this coordinate after it passes overhead moving toward the west.

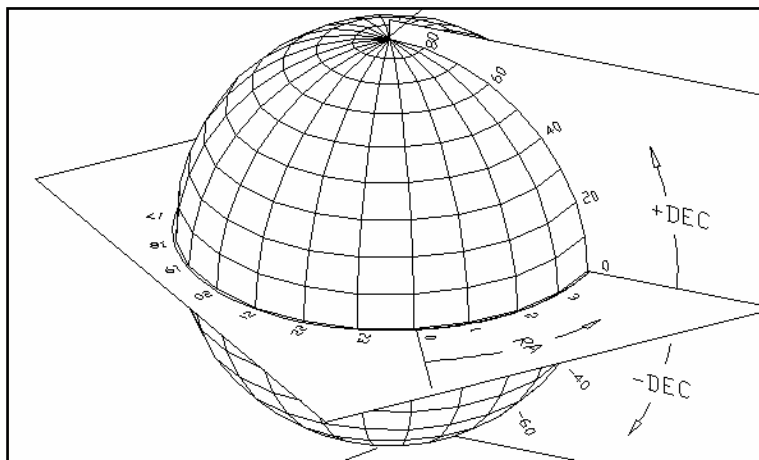
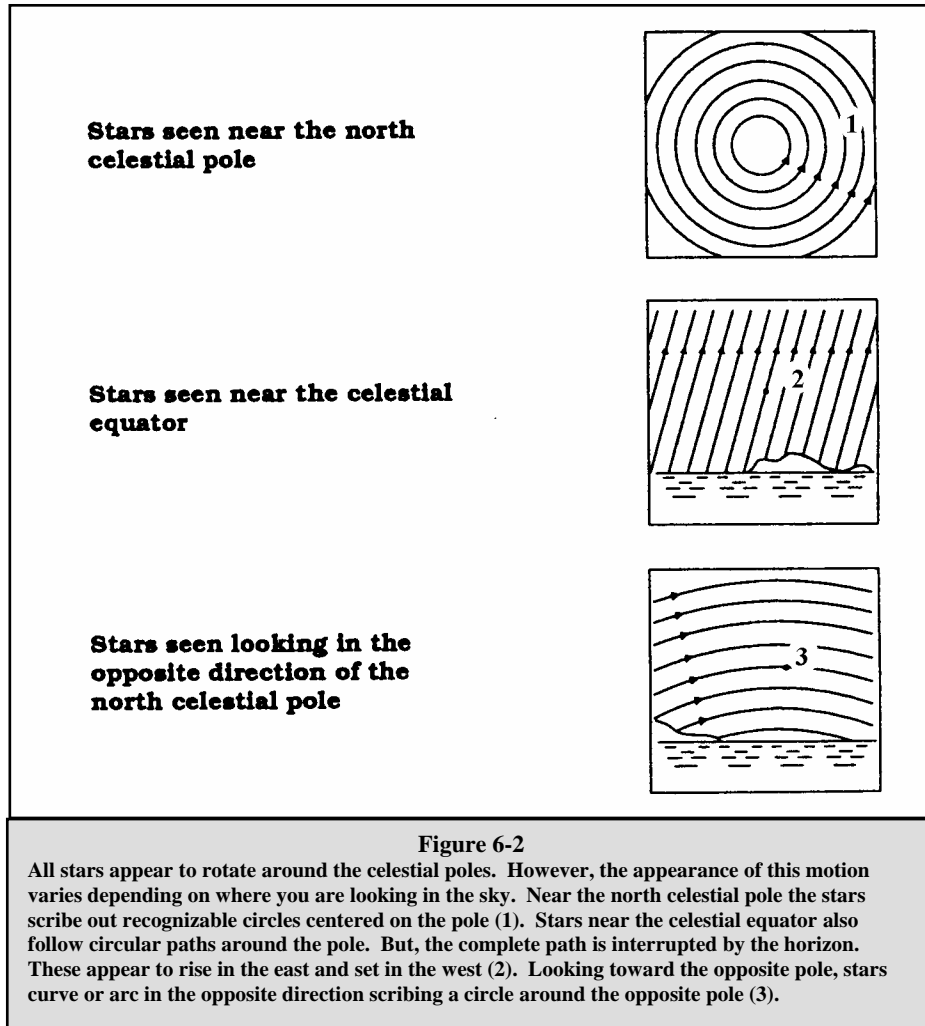

Figure 6-1
The celestial sphere seen from the outside showing R.A. and DEC.

Motion of the Stars

The daily motion of the Sun across the sky is familiar to even the most casual observer. This daily trek is not the Sun moving as early astronomers thought, but the result of the Earth's rotation. The Earth's rotation also causes the stars to do the same, scribing out a large circle as the Earth completes one rotation. The size of the circular path a star follows depends on where it is in the sky. Stars near the celestial equator form the largest circles rising in the east and setting in the west. Moving toward the north celestial pole, the point around which the stars in the northern hemisphere appear to rotate, these circles become smaller. Stars in the mid-celestial latitudes rise in the northeast and set in the northwest. Stars at high celestial latitudes are always above the horizon, and are said to be circumpolar because they never rise and never set. You will never see the stars complete one circle because the sunlight during the day washes out the starlight. However, part of this circular motion of stars in this region of the sky can be seen by setting up a camera on a tripod and opening the shutter for a couple hours. The processed film will reveal semicircles that revolve around the pole. (This description of stellar motions also applies to the southern hemisphere except all stars south of the celestial equator move around the south celestial pole.)



Polar Alignment (with optional Wedge)

Even though the CPC can precisely track a celestial object while in the Alt-Az position, it is still necessary to align the polar axis of the telescope (the fork arm) to the Earth's axis of rotation in order to do long exposure astrophotography. To do an accurate polar alignment, the CPC requires an optional equatorial wedge between the telescope and the tripod. This allows the telescope's tracking motors to rotate the telescope around the celestial pole, the same way as the stars. Without the equatorial wedge, you would notice the stars in the eyepiece would slowly rotate around the center of the field of view. Although this gradual rotation would go unnoticed when viewing with an eyepiece, it would be very noticeable on film.

Polar alignment is the process by which the telescope's axis of rotation (called the polar axis) is aligned (made parallel) with the Earth's axis of rotation. Once aligned, a telescope with a clock drive will track the stars as they move across the sky. The result is that objects observed through the telescope appear stationary (i.e., they will not drift out of the field of view). If not using the clock drive, all objects in the sky (day or night) will slowly drift out of the field. This motion is caused by the Earth's rotation.

Wedge Align

The CPC has two equatorial wedge alignment modes (one for the northern hemisphere and one for the southern) that will help you polar align your telescope when using an optional equatorial wedge. After performing either an EQ AutoAlign or Two-Star Alignment, Wedge Align will slew the telescope to where Polaris should be. By using the tripod and wedge to center Polaris in the eyepiece, the fork arm (polar axis) will then be pointing towards the actual North Celestial Pole. Once Wedge Align is complete, you must re-align your telescope using any of the EQ alignment methods. Follow these steps to Wedge Align the CPC in the Northern Hemisphere:

1. With the telescope set up on an optional equatorial wedge and roughly positioned towards Polaris, align the CPC using either the EQ AutoAlign or Two-Star Alignment method.
2. Select *Wedge Align* from the Utilities menu and press Enter.

Based on your current alignment, the CPC will slew to where it thinks Polaris should be. Use the tripod and wedge adjustments to place Polaris in the center of the eyepiece. Do not use the direction buttons to position Polaris. Once Polaris is centered in the eyepiece press ENTER; the polar axis should then be pointed towards the North Celestial Pole.

Finding the North Celestial Pole

In each hemisphere, there is a point in the sky around which all the other stars appear to rotate. These points are called the celestial poles and are named for the hemisphere in which they reside. For example, in the northern hemisphere all stars move around the north celestial pole. When the telescope's polar axis is pointed at the celestial pole, it is parallel to the Earth's rotational axis.

Many methods of polar alignment require that you know how to find the celestial pole by identifying stars in the area. For those in the northern hemisphere, finding the celestial pole is not too difficult. Fortunately, we have a naked eye star less than a degree away. This star, Polaris, is the end star in the handle of the Little Dipper. Since the Little Dipper (technically called Ursa Minor) is not one of the brightest constellations in the sky, it may be difficult to locate from urban areas. If this is the case, use the two end stars in the bowl of the Big Dipper (the pointer stars). Draw an imaginary line through them toward the Little Dipper. They point to Polaris (see Figure 6-6). The position of the Big Dipper

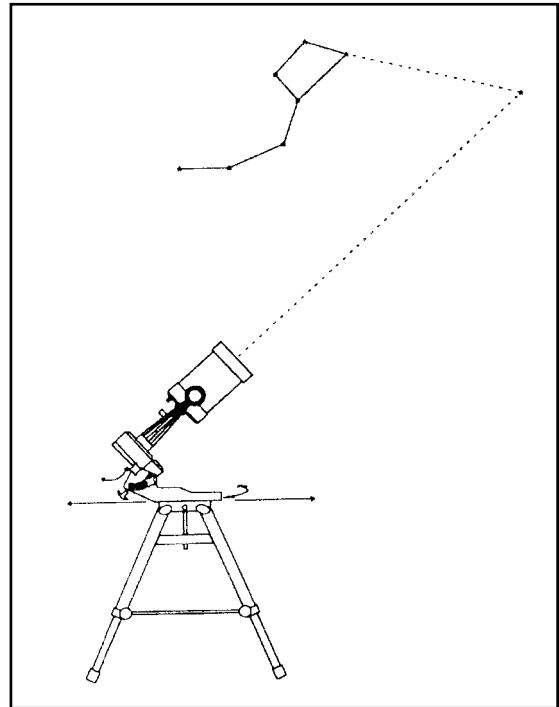

Figure 6-3
This is how the telescope is to be set up for polar alignment. The tube should be parallel to the fork arm and the mount should point to Polaris.

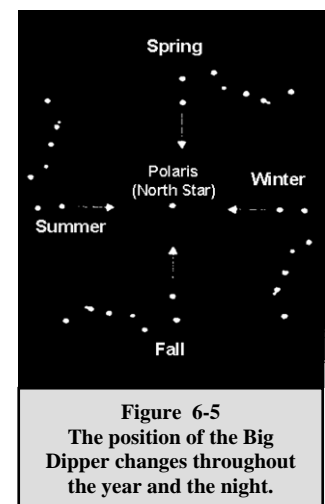

Figure 6-5
The position of the Big Dipper changes throughout the year and the night.

changes during the year and throughout the course of the night (see Figure 6-5). When the Big Dipper is low in the sky (i.e., near the horizon), it may be difficult to locate. During these times, look for Cassiopeia (see Figure 6-6). Observers in the southern hemisphere are not as fortunate as those in the northern hemisphere. The stars around the south celestial pole are not nearly as bright as those around the north. The closest star that is relatively bright is Sigma Octantis. This star is just within naked eye limit (magnitude 5.5) and lies about 59 arc minutes from the pole.

Definition

The north celestial pole is the point in the northern hemisphere around which all stars appear to rotate. The counterpart in the southern hemisphere is referred to as the south celestial pole.

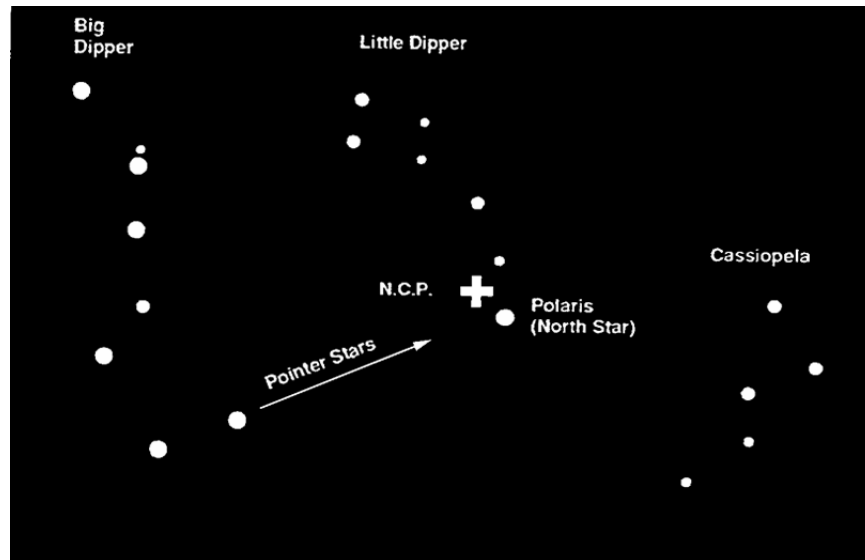

Figure 6-6
The two stars in the front of the bowl of the Big Dipper point to Polaris which is less than one degree from the true (north) celestial pole. Cassiopeia, the “W” shaped constellation, is on the opposite side of the pole from the Big Dipper. The North Celestial Pole (N.C.P.) is marked by the “+” sign.

Declination Drift Method of Polar Alignment

This method of polar alignment allows you to get the most accurate alignment on the celestial pole and is required if you want to do long exposure deep-sky astrophotography through the telescope. The declination drift method requires that you monitor the drift of selected stars. The drift of each star tells you how far away the polar axis is pointing from the true celestial pole and in what direction. Although declination drift is simple and straight-forward, it requires a great deal of time and patience to complete when first attempted. The declination drift method should be done after any one of the previously mentioned methods has been completed.

To perform the declination drift method you need to choose two bright stars. One should be near the eastern horizon and one due south near the meridian. Both stars should be near the celestial equator (i.e., 0° declination). You will monitor the drift of each star one at a time and in declination only. While monitoring a star on the meridian, any misalignment in the east-west direction is revealed. While monitoring a star near the east/west horizon, any misalignment in the north-south direction is revealed. It is helpful to have an illuminated reticle eyepiece to help you recognize any drift. For very close alignment, a Barlow lens is also recommended since it increases the magnification and reveals any drift faster. When looking due south, insert the diagonal so the eyepiece points straight up. Insert the cross hair eyepiece and align the cross hairs so that one is parallel to the declination axis and the other is parallel to the right ascension axis. Move your telescope manually in R.A. and DEC to check parallelism.

First, choose your star near where the celestial equator and the meridian meet. The star should be approximately within 1/2 an hour of the meridian and within five degrees of the celestial equator. Center the star in the field of your telescope and monitor the drift in declination.

- If the star drifts south, the polar axis is too far east.
- If the star drifts north, the polar axis is too far west.

Make the appropriate adjustments to the polar axis to eliminate any drift. Once you have eliminated all the drift, move to the star near the eastern horizon. The star should be 20 degrees above the horizon and within five degrees of the celestial equator.

- If the star drifts south, the polar axis is too low.
- If the star drifts north, the polar axis is too high.

Again, make the appropriate adjustments to the polar axis to eliminate any drift. Unfortunately, the latter adjustments interact with the prior adjustments ever so slightly. So, repeat the process again to improve the accuracy checking both axes for minimal drift. Once the drift has been eliminated, the telescope is very accurately aligned. You can now do prime focus deep-sky astrophotography for long periods.

NOTE: If the eastern horizon is blocked, you may choose a star near the western horizon, but you must reverse the polar high/low error directions. Also, if using this method in the southern hemisphere, the direction of drift is reversed for both R.A. and DEC.

Celestial Observing

With your telescope set up, you are ready to use it for observing. This section covers visual observing hints for both solar system and deep sky objects as well as general observing conditions which will affect your ability to observe.

Observing the Moon

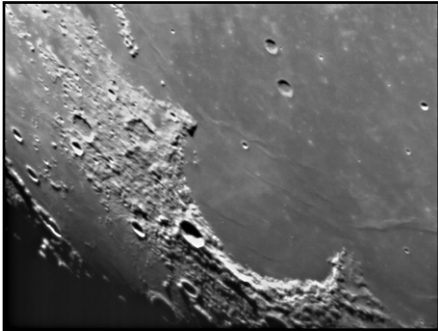

Often, it is tempting to look at the Moon when it is full. At this time, the face we see is fully illuminated and its light can be overpowering. In addition, little or no contrast can be seen during this phase.

One of the best times to observe the Moon is during its partial phases (around the time of first or third quarter). Long shadows reveal a great amount of detail on the lunar surface. At low power you will be able to see most of the lunar disk at one time. The optional Reducer/Corrector lens allows for breath-taking views of the entire lunar disk when used with a low power eyepiece. Change to higher power (magnification) to focus in on a smaller area. Choose the *lunar* tracking rate from the CPC's MENU tracking rate options to keep the moon centered in the eyepiece even at high magnifications.

Lunar Observing Hints

To increase contrast and bring out detail on the lunar surface, use filters. A yellow filter works well at improving contrast while a neutral density or polarizing filter will reduce overall surface brightness and glare.

Observing the Planets

Other fascinating targets include the five naked eye planets. You can see Venus go through its lunar-like phases. Mars can reveal a host of surface detail and one, if not both, of its polar caps. You will be able to see the cloud belts of Jupiter and the great Red Spot (if it is visible at the time you are observing). In addition, you will also be able to see the moons of Jupiter as they orbit the giant planet. Saturn, with its beautiful rings, is easily visible at moderate power.

Planetary Observing Hints

- Remember that atmospheric conditions are usually the limiting factor on how much planetary detail will be visible. So, avoid observing the planets when they are low on the horizon or when they are directly over a source of radiating heat, such as a rooftop or chimney. See the "Seeing Conditions" section later in this section.
- To increase contrast and bring out detail on the planetary surface, try using Celestron eyepiece filters.

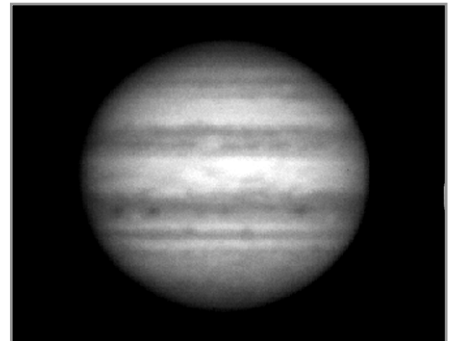

Observing the Sun

Although overlooked by many amateur astronomers, solar observation is both rewarding and fun. However, because the Sun is so bright, special precautions must be taken when observing our star so as not to damage your eyes or your telescope.

Never project an image of the Sun through the telescope. Because of the folded optical design, tremendous heat build-up will result inside the optical tube. This can damage the telescope and/or any accessories attached to the telescope.

For safe solar viewing, use a solar filter that reduces the intensity of the Sun's light, making it safe to view. With a filter you can see sunspots as they move across the solar disk and faculae, which are bright patches seen near the Sun's edge.

Solar Observing Hints

- The best time to observe the Sun is in the early morning or late afternoon when the air is cooler.
- To center the Sun without looking into the eyepiece, watch the shadow of the telescope tube until it forms a circular shadow.
- To ensure accurate tracking, be sure to select the solar tracking rate.

Observing Deep Sky Objects

Deep-sky objects are simply those objects outside the boundaries of our solar system. They include star clusters, planetary nebulae, diffuse nebulae, double stars and other galaxies outside our own Milky Way. Most deep-sky objects have a large angular size. Therefore, low-to-moderate power is all you need to see them. Visually, they are too faint to reveal any of the color seen in long exposure photographs. Instead, they appear black and white. And, because of their low surface brightness, they should be observed from a dark-sky location. Light pollution around large urban areas washes out most nebulae making them difficult, if not impossible, to observe. Light Pollution Reduction filters help reduce the background sky brightness, thus increasing contrast.

Seeing Conditions

Viewing conditions affect what you can see through your telescope during an observing session. Conditions include transparency, sky illumination, and seeing. Understanding viewing conditions and the effect they have on observing will help you get the most out of your telescope.

Transparency

Transparency is the clarity of the atmosphere which is affected by clouds, moisture, and other airborne particles. Thick cumulus clouds are completely opaque while cirrus can be thin, allowing the light from the brightest stars through. Hazy skies absorb more light than clear skies making fainter objects harder to see and reducing contrast on brighter objects. Aerosols ejected into the upper atmosphere from volcanic eruptions also affect transparency. Ideal conditions are when the night sky is inky black.

Sky Illumination

General sky brightening caused by the Moon, aurorae, natural airglow, and light pollution greatly affect transparency. While not a problem for the brighter stars and planets, bright skies reduce the contrast of extended nebulae making them difficult, if not impossible, to see. To maximize your observing, limit deep sky viewing to moonless nights far from the light polluted skies found around major urban areas. LPR filters enhance deep sky viewing from light polluted areas by blocking unwanted light while transmitting light from certain deep sky objects. You can, on the other hand, observe planets and stars from light polluted areas or when the Moon is out.

Seeing

Seeing conditions refers to the stability of the atmosphere and directly affects the amount of fine detail seen in extended objects. The air in our atmosphere acts as a lens which bends and distorts incoming light rays. The amount of bending depends on air density. Varying temperature layers have different densities and, therefore, bend light differently. Light rays from the same object arrive slightly displaced creating an imperfect or smeared image. These atmospheric disturbances vary from time-to-time and place-to-place. The size of the air parcels compared to your aperture determines the "seeing" quality. Under good seeing conditions, fine detail is visible on the brighter planets like Jupiter and Mars, and stars are pinpoint images. Under poor seeing conditions, images are blurred and stars appear as blobs.

The conditions described here apply to both visual and photographic observations.

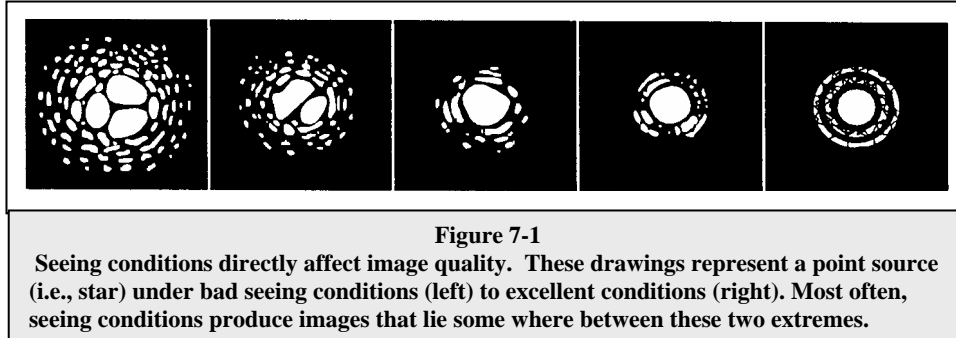



After looking at the night sky for a while you may want to try photographing it. Several forms of celestial photography are possible with your telescope, including short exposure prime focus, eyepiece projection, long exposure deep sky, terrestrial and even CCD imaging. Each of these is discussed in moderate detail with enough information to get you started. Topics include the accessories required and some simple techniques. More information is available in some of the publications listed at the end of this manual.

In addition to the specific accessories required for each type of celestial photography, there is the need for a camera - but not just any camera. The camera does not have to have many of the features offered on today's state-of-the-art equipment. For example, you don't need auto focus capability or mirror lock up. Here are the mandatory features a camera needs for celestial photography. First, a "B" setting which allows for time exposures. This excludes point and shoot cameras and limits the selection to SLR cameras, the most common type of 35mm camera on the market today.

Second, the "B" or manual setting should NOT run off the battery. Many new electronic cameras use the battery to keep the shutter open during time exposures. Once the batteries are drained, usually after a few minutes, the shutter closes, whether you were finished with the exposure or not. Look for a camera that has a manual shutter when operating in the time exposure mode. Olympus, Nikon, Minolta, Pentax, Canon and others have made such camera bodies.

The camera must have interchangeable lenses so you can attach it to the telescope and so you can use a variety of lenses for piggyback photography. If you can't find a new camera, you can purchase a used camera body that is not 100-percent functional. The light meter, for example, does not have to be operational since you will be determining the exposure length manually.

You also need a cable release with a locking function to hold the shutter open while you do other things. Mechanical and air release models are available.

Short Exposure Prime Focus Photography

Short exposure prime focus photography is the best way to begin recording celestial objects. It is done with the camera attached to the telescope without an eyepiece or camera lens in place. To attach your camera you need the Celestron T-Adapter (#93633-A) and a T-Ring for your specific camera (i.e., Minolta, Nikon, Pentax, etc.). The T-Ring replaces the 35mm SLR camera's normal lens. Prime focus photography allows you to capture the majority of the lunar disk or solar disk. To attach your camera to your telescope.

1. Remove all visual accessories.
2. Thread the T-Ring onto the T-Adapter.
3. Mount your camera body onto the T-Ring the same as you would any other lens.
4. Thread the T-Adapter onto the back of the telescope while holding the camera in the desired orientation (either vertical or horizontal).

With your camera attached to the telescope, you are ready for prime focus photography. Start with an easy object like the Moon. Here's how to do it:

1. Load your camera with film that has a moderate-to-fast speed (i.e., ISO rating). Faster films are more desirable when the Moon is a crescent. When the Moon is near full, and at its brightest, slower films are more desirable. Here are some film recommendations:
 - T-Max 100
 - T-Max 400
 - Any 100 to 400 ISO color slide film
 - Fuji Super HG 400
 - Ektar 25 or 100
2. Center the Moon in the field of your CPC telescope.
3. Focus the telescope by turning the focus knob until the image is sharp.
4. Set the shutter speed to the appropriate setting (see table below).
5. Trip the shutter using a cable release.

- Advance the film and repeat the process.

Lunar Phase	ISO 50	ISO 100	ISO 200	ISO 400
Crescent	1/2	1/4	1/8	1/15
Quarter	1/15	1/30	1/60	1/125
Full	1/30	1/60	1/125	1/250

Table 8-1
Above is a listing of recommended exposure times when photographing the Moon at the prime focus of your CPC telescope.

The exposure times listed in table 8-1 should be used as a starting point. Always make exposures that are longer and shorter than the recommended time. Also, take a few photos at each shutter speed. This will ensure that you will get a good photo.

- If using black and white film, try a yellow filter to reduce the light intensity and to increase contrast.
- Keep accurate records of your exposures. This information is useful if you want to repeat your results or if you want to submit some of your photos to various astronomy magazines for possible publication!
- This technique is also used for photographing the Sun with the proper solar filter.

Eyepiece Projection

This form of celestial photography is designed for objects with small angular sizes, primarily the Moon and planets. Planets, although physically quite large, appear small in angular size because of their great distances. Moderate to high magnification is, therefore, required to make the image large enough to see any detail. Unfortunately, the camera/telescope combination alone does not provide enough magnification to produce a usable image size on film. In order to get the image large enough, you must attach your camera to the telescope with the eyepiece in place. To do so, you need two additional accessories; a deluxe tele-extender (#93643), which attaches to the visual back, and a T-ring for your particular camera make (i.e., Minolta, Nikon, Pentax, etc.).

Because of the high magnifications during eyepiece projection, the field of view is quite small which makes it difficult to find and center objects. To make the job a little easier, align the finder as accurately as possible. This allows you to get the object in the telescope's field based on the finder's view alone.

Another problem introduced by the high magnification is vibration. Simply tripping the shutter — even with a cable release — produces enough vibration to smear the image. To get around this, use the camera's self-timer if the exposure time is less than one second — a common occurrence when photographing the Moon. For exposures over one second, use the "hat trick." This technique incorporates a hand-held black card placed over the aperture of the telescope to act as a shutter. The card prevents light from entering the telescope while the shutter is released. Once the shutter has been released and the vibration has diminished (a few seconds), move the black card out of the way to expose the film. After the exposure is complete, place the card over the front of the telescope and close the shutter. Advance the film and you're ready for your next shot. Keep in mind that the card should be held a few inches in front of the telescope, and not touching it. It is easier if you use two people for this process; one to release the camera shutter and one to hold the card. Here's the process for making the exposure.

- Find and center the desired target in the viewfinder of your camera.
- Turn the focus knob until the image is as sharp as possible.
- Place the black card over the front of the telescope.
- Release the shutter using a cable release.
- Wait for the vibration caused by releasing the shutter to diminish. Also, wait for a moment of good seeing.
- Remove the black card from in front of the telescope for the duration of the exposure (see accompanying table).
- Replace the black card over the front of the telescope.
- Close the camera's shutter.

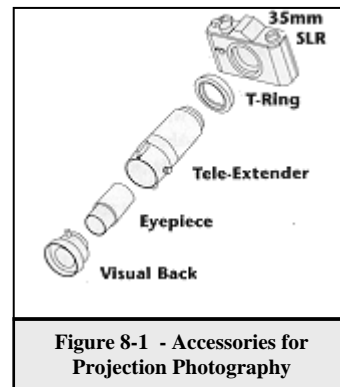

Advance the film and you are ready for your next exposure. Don't forget to take photos of varying duration and keep accurate records of what you have done. Record the date, telescope, exposure duration, eyepiece, f/ratio, film, and some comments on the seeing conditions.

The following table lists exposures for eyepiece projection with a 10mm eyepiece. All exposure times are listed in seconds or fractions of a second.

Planet	ISO 50	ISO 100	ISO 200	ISO 400
Moon	4	2	1	1/2
Mercury	16	8	4	2
Venus	1/2	1/4	1/8	1/15
Mars	16	8	4	2
Jupiter	8	4	2	1
Saturn	16	8	4	2

Table 8-2
Recommended exposure time for photographing planets.

The exposure times listed here should be used as a starting point. Always make exposures that are longer and shorter than the recommended time. Also, take a few photos at each shutter speed. This will ensure that you get a good photo. It is not uncommon to go through an entire roll of 36 exposures and have only one good shot.

NOTE: Don't expect to record more detail than you can see visually in the eyepiece at the time you are photographing.

Once you have mastered the technique, experiment with different films, different focal length eyepieces, and even different filters.

Long Exposure Prime Focus Photography

This is the last form of celestial photography to be attempted after others have been mastered. It is intended primarily for deep sky objects, that is objects outside our solar system which includes star clusters, nebulae, and galaxies. While it may seem that high magnification is required for these objects, just the opposite is true. Most of these objects cover large angular areas and fit nicely into the prime focus field of your telescope. The brightness of these objects, however, requires long exposure times and, as a result, are rather difficult.

There are several techniques for this type of photography, and the one chosen will determine the standard accessories needed. The best method for long exposure deep sky astrophotography is with an off-axis guider. This device allows you to photograph and guide through the telescope simultaneously. Celestron offers a very special and advanced off-axis guider, called the Radial Guider (#94176). In addition, you will need a T-Ring to attach your camera to the Radial Guider.

Other equipment needs include a guiding eyepiece. Unlike other forms of astrophotography which allows for fairly loose guiding, prime focus requires meticulous guiding for long periods. To accomplish this you need a guiding ocular with an illuminated reticle to monitor your guide star. For this purpose, Celestron offers the Micro Guide Eyepiece (#94171) Here is a brief summary of the technique.

1. Polar align the telescope using an optional equatorial wedge. To polar align the CPC you must select EQ North Align (or EO South Align) from the alignment options. For more information on polar aligning, see the Polar Alignment section earlier in the manual.
2. Remove all visual accessories.
3. Thread the Radial Guider onto your telescope.
4. Thread the T-Ring onto the Radial Guider.
5. Mount your camera body onto the T-Ring the same as you would any other lens.
6. Set the shutter speed to the "B" setting.
7. Focus the telescope on a star.
8. Center your subject in the field of your camera.
9. Find a suitable guide star in the telescope field. This can be the most time consuming process.
10. Open the shutter using a cable release.
11. Monitor your guide star for the duration of the exposure using the buttons on the hand controller to make the needed corrections.

12. Close the camera's shutter.

Periodic Error Correction (PEC)

PEC for short, is a system that improves the tracking accuracy of the drive by reducing the number of user corrections needed to keep a guide star centered in the eyepiece. PEC is designed to improve photographic quality by reducing the amplitude of the worm errors. Using the PEC function is a three-step process. First, the CPC needs to know the current position of its worm gear so that it has a reference when playing back the recorded error. Next, you must guide for at least 8 minutes during which time the system records the correction you make. (It takes the worm gear 8 minutes to make one complete revolution, hence the need to guide for 8 minutes). This “teaches” the PEC chip the characteristics of the worm. The periodic error of the worm gear drive will be stored in the PEC chip and used to correct periodic error. The last step is to play back the corrections you made during the recording phase. Keep in mind, this feature is for advanced astrophotography and still requires careful guiding since all telescope drives have some periodic error.

Using Periodic Error Correction

Once the telescope has been polar aligned using the *EQ North Align* (or *EQ South* for southern hemisphere) method, select *PEC* from the *Utilities* menu and press ENTER to begin recording your periodic error. Here's how to use the PEC function.

1. Find a bright star relatively close to the object you want to photograph.
2. Insert a high power eyepiece with illuminated cross hairs into your telescope. Orient the guiding eyepiece cross hairs so that one is parallel to the declination while the other is parallel to the R.A. axis.
3. Center the guide star on the illuminated cross hairs, focus the telescope, and study the periodic movement.
4. Before actually recording the periodic error, take a few minutes to practice guiding. Set the hand control slew rate to an appropriate guide rate (rate 1 = .5x, rate 2 = 1x) and practice centering the guide star in the cross hairs for several minutes. This will help you familiarize yourself with the periodic error of the drive and the operation of the hand control. Remember to ignore declination drift when programming the PEC.

Note: When recording PEC only the photo guide rates (rates 1 and 2) will be operational. This eliminates the possibility of moving the telescope suddenly while recording.

5. To begin recording the drive's periodic error, press the MENU button and select PEC from the Utilities menu. Use the Up/Down scroll buttons to display the *Record* option and press ENTER. You will have 5 seconds before the system starts to record. The first time each observing session that PEC record or play is selected, the worm gear must rotate in order to mark its starting position. If the rotation of the worm gear moves your guide star outside the field of view of the eyepiece, it will have to be re-centered before the recording begins.

Helpful Hint

Once the worm gear is indexed, it will not need to be positioned again until the telescope is turned-off. So, to give yourself more time to prepare for guiding, it is best to restart PEC recording after the worm gear has found its index.

6. After 8 minutes PEC will automatically stop recording.
7. Point the telescope at the object you want to photograph and center the guide star on the illuminated cross hairs and you are ready to play back the periodic error correction.
8. Once the drive's periodic error has been recorded, use the *Playback* function to begin playing back the correction for future photographic guiding. If you want to re-record the periodic error, select *Record* and repeat the recording processes again. The previously recorded information will be replaced with the current information. Repeat steps 7 and 8 to playback the PEC corrections for your next object.

Does the PEC function make unguided astrophotography possible? Yes and no. For solar (filtered), lunar, and piggyback (up to 200mm), the answer is yes. However, even with PEC, off-axis guiding is still mandatory for long exposure, deep sky astrophotography. The optional Reducer/Corrector lens reduces exposure times making the task of guiding a little easier.

When getting started, use fast films to record as much detail in the shortest possible time. Here are proven recommendations:

- Ektar 1000 (color print)

- Konica 3200 (color print)
- Fujichrome 1600D (color slide)
- 3M 1000 (color slide)
- Scotchchrome 400
- T-Max 3200 (black and white print)
- T-Max 400 (black and white print)

As you perfect your technique, try specialized films, that is films that are designed or specially treated for celestial photography. Here are some popular choices:

- Ektar 125 (color print)
- Fujichrome 100D (color slide)
- Tech Pan, gas hypered (black and white print)
- T-Max 400 (black and white print)

There is no exposure determination table to help you get started. The best way to determine exposure length is look at previously published photos to see what film/exposure combinations were used. Or take unguided sample photos of various parts of the sky while the drive is running. Always take exposures of various lengths to determine the best exposure time.

Terrestrial Photography

Your CPC makes an excellent telephoto lens for terrestrial (land) photography. Terrestrial photography is best done with the telescope in Alt-Az configuration and the tracking drive turned off. To turn the tracking drive off, press the MENU (9) button on the hand control and scroll down to the Tracking Mode sub menu. Use the Up and Down scroll keys (10) to select the Off option and press ENTER. This will turn the tracking motors off, so that objects will remain in your camera's field of view.

Metering

The CPC has a fixed aperture and, as a result, fixed f/ratios. To properly expose your subjects photographically, you need to set your shutter speed accordingly. Most 35mm SLR cameras offer through-the-lens metering which lets you know if your picture is under or overexposed. Adjustments for proper exposures are made by changing the shutter speed. Consult your camera manual for specific information on metering and changing shutter speeds.

Reducing Vibration

Releasing the shutter manually can cause vibrations, producing blurred photos. To reduce vibration when tripping the shutter, use a cable release. A cable release keeps your hands clear of the camera and lens, thus eliminating the possibility of introducing vibration. Mechanical shutter releases can be used, though air-type releases are best.

Blurry pictures can also result from shutter speeds that are too slow. To prevent this, use films that produce shutter speeds greater than 1/250 of a second when hand-holding the lens. If the lens is mounted on a tripod, the exposure length is virtually unlimited.

Another way to reduce vibration is with the Vibration Suppression Pads (#93503). These pads rest between the ground and tripod feet. They reduce the vibration amplitude and vibration time.

The following is a brief description of the advantages of imaging at each f-number configuration and the proper equipment needed to use the telescope in any of its many settings

F/6.3 with Reducer/Corrector

When imaging some objects like planetary nebula (for example M57, the Ring Nebula) and small galaxies (M104, the Sombrero Galaxy), larger image scale is needed to resolve finer detail. These objects are better shot at f/6.3 or even f/10.

Medium size to small galaxies --

f/6.3 imaging gives you finer resolution than at f/2, but the slower f-number will usually require you to guide the image while you are taking longer exposures. Guiding can be accomplished by using an optional Radial Guider or a piggyback guide scope. The exposure times are about 10 times longer but the results can be worth the extra effort. There are some objects that are small enough and bright enough that they work great at f/6.3. M104 (the Sombrero Galaxy) can be imaged under dark skies with a series of short exposures using Track and Accumulate. Ten exposures at 15 seconds each will yield a nice image and is short enough that you may not need to guide the exposure at all. For f/6.3 imaging the optional Reducer/Corrector is needed. (See Optional Accessory section at the end of this manual).

Lunar or small planetary nebulae--
f/10 imaging is more challenging for long exposure, deep-sky imaging. Guiding needs to be very accurate and the exposure times need to be much longer, about 25 times longer than f/2. There are only a select few objects that work well at f/10. The moon images fine because it is so bright, but planets are still a bit small and should be shot at f/20. The Ring nebula is a good candidate because it is small and bright. The Ring Nebula (M57) can be imaged in about 30-50 seconds at f/10. The longer the exposure the better.

Planetary or Lunar--
f/20 is a great way to image the planets and features on the moon. When imaging the planets, very short exposures are needed. The exposure lengths range from .03 to .1 seconds on planetary images. Focus is critical as is good atmospheric conditions. Generally you will take one image after another until one looks good. This is due to the atmospheric "seeing" conditions. For every 10 exposures you might save 1. To image at f/20 you need to purchase a 2x Barlow and a T-adapter or Radial Guider.

Auto Guiding

The CPC has a designated auto guiding port for use with a CCD autoguider. The diagram below may be useful when connecting the CCD camera cable to the CPC and calibrating the autoguider. Note that the four outputs are active-low, with internal pull-ups and are capable of sinking 25 mA DC.

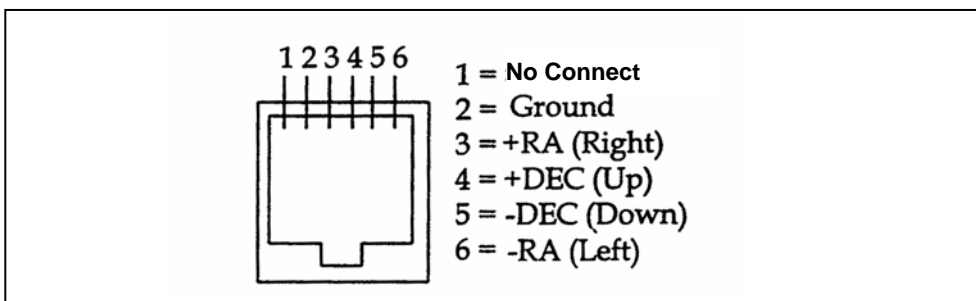

Figure 8-7 – Pin out diagram for Autoguider port.



Telescope Maintenance

While your CPC telescope requires little maintenance, there are a few things to remember that will ensure your telescope performs at its best.

Care and Cleaning of the Optics

Occasionally, dust and/or moisture may build up on the corrector plate of your telescope. Special care should be taken when cleaning any instrument so as not to damage the optics.

If dust has built up on the corrector plate, remove it with a brush (made of camel's hair) or a can of pressurized air. Spray at an angle to the lens for approximately two to four seconds. Then, use an optical cleaning solution and white tissue paper to remove any remaining debris. Apply the solution to the tissue and then apply the tissue paper to the lens. Low pressure strokes should go from the center of the corrector to the outer portion. **Do NOT rub in circles!**

You can use a commercially made lens cleaner or mix your own. A good cleaning solution is isopropyl alcohol mixed with distilled water. The solution should be 60% isopropyl alcohol and 40% distilled water. Or, liquid dish soap diluted with water (a couple of drops per one quart of water) can be used.

Occasionally, you may experience dew build-up on the corrector plate of your telescope during an observing session. If you want to continue observing, the dew must be removed, either with a hair dryer (on low setting) or by pointing the telescope at the ground until the dew has evaporated.

If moisture condenses on the inside of the corrector, remove the accessories from the rear cell of the telescope. Place the telescope in a dust-free environment and point it down. This will remove the moisture from the telescope tube.

To minimize the need to clean your telescope, replace all lens covers once you have finished using it. Since the rear cell is NOT sealed, the cover should be placed over the opening when not in use. This will prevent contaminants from entering the optical tube.

Internal adjustments and cleaning should be done only by the Celestron repair department. If your telescope is in need of internal cleaning, please call the factory for a return authorization number and price quote.

Collimation



Figure 9-1
Collimation Adjustment Screws

The optical performance of your CPC telescope is directly related to its collimation, that is the alignment of its optical system. Your CPC was collimated at the factory after it was completely assembled. However, if the telescope is dropped or jarred severely during transport, it may have to be collimated. The only optical element that may need to be adjusted, or is possible, is the tilt of the secondary mirror.

To check the collimation of your telescope you will need a light source. A bright star near the zenith is ideal since there is a minimal amount of atmospheric distortion. Make sure that tracking is on so that you won't have to manually track the star. Or, if you do not want to power up your telescope, you can use Polaris. Its position relative to the celestial pole means that it moves very little thus eliminating the need to manually track it.

Before you begin the collimation process, be sure that your telescope is in thermal equilibrium with the surroundings. Allow 45 minutes for the telescope to reach equilibrium if you move it between large temperature extremes.

To verify collimation, view a star near the zenith. Use a medium to high power ocular — 12mm to 6mm focal length. It is important to center a star in the center of the field to judge collimation. Slowly cross in and out of focus and judge the symmetry of the star. If you see a systematic skewing of the star to one side, then re-collimation is needed.

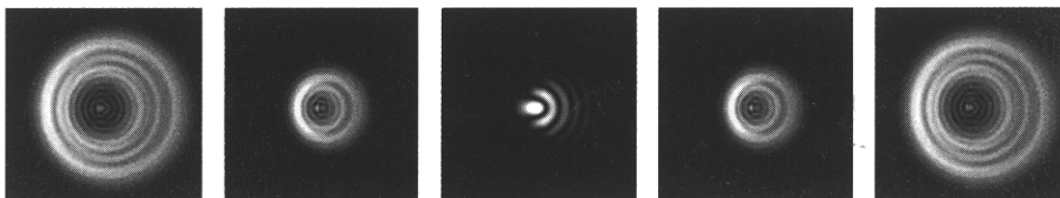
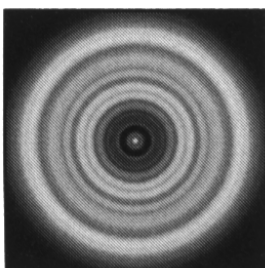

Figure 9-2 -- Even though the star pattern appears the same on both sides of focus, they are asymmetric. The dark obstruction is skewed off to the left side of the diffraction pattern indicating poor collimation.

To accomplish this, you need to tighten the secondary collimation screw(s) that move the star across the field toward the direction of the skewed light. These screws are located on the secondary mirror holder (see figure 9-1). To access the collimation screws you will need remove the collimation screw cover to expose the three collimation screws underneath. To remove the cover place the tip of flat screwdriver underneath the cover and twist until the cover lifts off. Make only small 1/6 to 1/8 adjustments to the collimation screws and re-center the star by moving the scope before making any improvements or before making further adjustments.

To make collimation a simple procedure, follow these easy steps:

1. While looking through a medium to high power eyepiece, de-focus a bright star until a ring pattern with a dark shadow appears (see figure 9-2). Center the de-focused star and notice in which direction the central shadow is skewed.
2. Place your finger along the edge of the front cell of the telescope (be careful not to touch the corrector plate), pointing towards the collimation screws. The shadow of your finger should be visible when looking into the eyepiece. Rotate your finger around the tube edge until its shadow is seen closest to the narrowest portion of the rings (i.e. the same direction in which the central shadow is skewed).
3. Locate the collimation screw closest to where your finger is positioned. This will be the collimation screw you will need to adjust first. (If your finger is positioned exactly between two of the collimation screws, then you will need to adjust the screw opposite where your finger is located).
4. Use the hand control buttons to move the de-focused star image to the edge of the field of view, in the same direction that the central obstruction of the star image is skewed.
5. While looking through the eyepiece, use an Allen wrench to turn the collimation screw you located in step 2 and 3. Usually a tenth of a turn is enough to notice a change in collimation. If the star image moves out of the field of view in the direction that the central shadow is skewed, than you are turning the collimation screw the wrong way. Turn the screw in the opposite direction, so that the star image is moving towards the center of the field of view.
6. If while turning you notice that the screws get very loose, then simply tighten the other two screws by the same amount. Conversely, if the collimation screw gets too tight, then loosen the other two screws by the same amount.
7. Once the star image is in the center of the field of view, check to see if the rings are concentric. If the central obstruction is still skewed in the same direction, then continue turning the screw(s) in the same direction. If you find that the ring pattern is skewed in a different direction, than simply repeat steps 2 through 6 as described above for the new direction.



**Figure 9-3
A collimated telescope should appear symmetrical with the central obstruction centered in the star's diffraction pattern.**

Perfect collimation will yield a star image very symmetrical just inside and outside of focus. In addition, perfect collimation delivers the optimal optical performance specifications that your telescope is built to achieve.

If seeing (i.e., air steadiness) is turbulent, collimation is difficult to judge. Wait until a better night if it is turbulent or aim to a steadier part of the sky. A steadier part of the sky is judged by steady versus twinkling stars.

CELESTRON Optional Accessories

You will find that additional accessories enhance your viewing pleasure and expand the usefulness of your telescope. For ease of reference, all the accessories are listed in alphabetical order.

Barlow Lens - A Barlow lens is a negative lens that increases the focal length of a telescope. Used with any eyepiece, it doubles the magnification of that eyepiece. Celestron offers two Barlow lens in the 1-1/4" size for the CPC. The 2x Ultima Barlow (#93506) is a compact triplet design that is fully multicoated for maximum light transmission and parfocal when used with the Ultima eyepieces. Model #93507 is a compact achromatic Barlow lens that is under three inches long and weighs only 4 oz. It works very well with all Celestron eyepieces.

Erect Image Diagonal (#94112-A) - This accessory is an Amici prism arrangement that allows you to look into the telescope at a 45° angle with images that are oriented properly (upright and correct from left-to-right). It is useful for daytime, terrestrial viewing.

Eyepieces - Like telescopes, eyepieces come in a variety of designs. Each design has its own advantages and disadvantages. For the 1-1/4" barrel diameter there are four different eyepiece designs available.

- **OMNI Plössl** - Plössl eyepieces have a 4-element lens designed for low-to-high power observing. All are fully multi-coated for maximum light transmission. These Plössls offer razor sharp views across the entire field, even at the edges! In the 1-1/4" barrel diameter, they are available in the following focal lengths: 3.6mm, 6mm, 8mm, 10mm, 13mm, 17mm, 25mm, 32mm and 40mm.
- **X-CEL** - Fully Multi-coated. All air-to-glass surfaces have 5 layer multi-coating. Field of view 55°. Six element optical design using ED glass on most curved elements. Parfocal – little to no focusing adjustments are needed when switching from a low power to high power eyepiece. 20mm eye relief and soft rubber eyecups. Blackened lens edges to minimize internal reflection and improved contrast. Each eyepiece comes in a durable plastic case.
- **Ultima** - Ultima is our 5-element, wider field eyepiece design. In the 1-1/4" barrel diameter, they are available in the following focal lengths: 5mm, 7.5mm, 10mm, 12.5mm, 18mm, 30mm, 35mm, and 42mm. These eyepieces are all parfocal. The 35mm Ultima gives the widest possible field of view with a 1-1/4" diagonal.
- **Axiom** - As an extension of the Ultima line, a new wide angle series is offered – called the Axiom series. All units are seven element designs and feature a 70° extra wide field of view (except the 50mm). All are fully multicoated and contain all the feature of the Ultimas.



Eyepiece, Micro Guide (#94171) - This multipurpose 12.5mm illuminated reticle can be used for guiding deep-sky astrophotos, measuring position angles, angular separations, and more. The laser etched reticle provides razor sharp lines and the variable brightness illuminator is completely cordless. The micro guide eyepiece produces 224 power when used with the CPC 11 at f/10 and 163 power with the CPC 8.

Filters, Eyepiece - To enhance your visual observations of solar system objects, Celestron offers a wide range of colored filters that thread into the 1-1/4" oculars. Available individually are: #12 deep yellow, #21 orange, #25 red, #58 green, #80A light blue, #96 neutral density - 25%T, #96 neutral density - 13%T, and polarizing. These and other filters are also sold in sets.

Flashlight, Night Vision - (#93588) - Celestron's premium model for astronomy, using two red LED's to preserve night vision better than red filters or other devices. Brightness is adjustable. Operates on a single 9 volt battery (included).

Light Pollution Reduction (LPR) Filters - These filters are designed to enhance your views of deep sky astronomical objects when viewed from urban areas. LPR Filters selectively reduce the transmission of certain wavelengths of light, specifically those produced by artificial lights. This includes mercury and high and low pressure sodium vapor lights. In addition, they also block unwanted natural light (sky glow) caused by neutral oxygen emission in our atmosphere. Celestron offers a model for 1-1/4" eyepieces (#94123) and 2" eyepieces (#94124)

Moon Filter (#94119-A) - Celestron's Moon Filter is an economical eyepiece filter for reducing the brightness of the moon and improving contrast, so greater detail can be observed on the lunar surface. The clear aperture is 21mm and the transmission is about 18%.



PowerTank (#18774) - 12v 7Amp hour rechargeable power supply. Comes with two 12v output cigarette outlets, built-in red flash light, Halogen emergency spotlight. 120v AC adapter and cigarette lighter adapter included. Celestron also offers a 17 amp hour models (#18777).

Polarizing Filter Set (#93608) - The polarizing filter set limits the transmission of light to a specific plane, thus increasing contrast between various objects. This is used primarily for terrestrial, lunar and planetary observing.

Radial Guider (#94176) - The Celestron Radial Guider® is specifically designed for use in prime focus, deep sky astrophotography and takes the place of the T-Adapter. This device allows you to photograph and guide

simultaneously through the optical tube assembly of your telescope. This type of guiding produces the best results since what you see through the guiding eyepiece is exactly reproduced on the processed film. The Radial Guider is a "T"-shaped assembly that attaches to the rear cell of the telescope. As light from the telescope enters the guider, most passes straight through to the camera. A small portion, however, is diverted by a prism at an adjustable angle up to the guiding eyepiece. This guider has two features not found on other off-axis guiders; first, the prism and eyepiece housing rotate independently of the camera orientation making the acquisition of a guide star quite easy. Second, the prism angle is tunable allowing you to look at guide stars on-axis. This accessory works especially well with the Reducer/Corrector.



Reducer/Corrector (#94175) - This lens reduces the focal length of the telescope by 37%, making your CPC 11 a 1764mm f/6.3 instrument and the CPC 800 a 1280mm f/6.3 instrument. In addition, this unique lens also corrects inherent aberrations to produce crisp images all the way across the field when used visually. When used photographically, there is some vignetting that produces a 26mm circular image on the processed film. It also increases the field of view significantly and is ideal for wide-field, deep-space viewing. It is also perfect for beginning prime focus, long-exposure astro photography when used with the radial guider. It makes guiding easier and exposures much shorter.

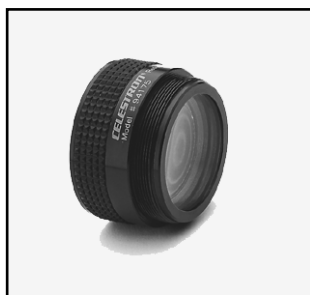

Sky Maps (#93722) - Celestron Sky Maps are the ideal teaching guide for learning the night sky. You wouldn't set off on a road trip without a road map, and you don't need to try to navigate the night sky without a map either. Even if you already know your way around the major constellations, these maps can help you locate all kinds of fascinating objects.

Skylight Filter (#93621) - The Skylight Filter is used on the Celestron CPC telescope as a dust seal. The filter threads onto the rear cell of your telescope. All other accessories, both visual and photographic (with the exception of Barlow lenses), thread onto the skylight filter. The light loss caused by this filter is minimal.

Solar Filter - The AstroSolar® filter is a safe and durable filter that covers the front opening of the telescope. View sunspots and other solar features using this double-sided metal coated filter for uniform density and good color balance across the entire field. The Sun offers constant changes and will keep your observing interesting and fun. Celestron offers filters for CPC 800 (#94162).

T-Adapter (#93633-A) - T-Adapter (with additional T-Ring) allows you to attach your SLR camera to the rear cell of your Celestron CPC. This turns your CPC into a high power telephoto lens perfect for terrestrial photography and short exposure lunar and filtered solar photography.

T-Ring - The T-Ring couples your 35mm SLR camera body to the T-Adapter, radial guider, or tele-extender. This accessory is mandatory if you want to do photography through the telescope. Each camera make (i.e., Minolta, Nikon, Pentax, etc.) has its own unique mount and therefore, its own T-Ring. Celestron has 8 different models for 35mm cameras.

Tele-Extender, Deluxe (#93643) - The tele-extender is a hollow tube that allows you to attach a camera to the telescope when the eyepiece is installed. This accessory is used for eyepiece projection photography which allows you to capture very high power views of the Sun, Moon, and planets on film. The tele-extender fits over the eyepiece onto the visual back. This tele-extender works with eyepieces that have large housings, like the Celestron Ultima series.

Wedge, Heavy Duty (#93655) - The wedge allows you to tilt the telescope so that its polar axis is parallel to the earth's axis of rotation. Ideal for using your CPC for guided astrophotography.

A full description of all Celestron accessories can be found in the Celestron Accessory Catalog (#93685).

Appendix A - Technical Specifications

Optical Specification	CPC 800 - #11073	CPC 925 - #11074	CPC 1100 - #11075
Design	Schmidt-Cassegrain Catadioptric	Schmidt-Cassegrain Catadioptric	Schmidt-Cassegrain Catadioptric
Aperture	8" (203.2mm)	9.25" (235mm)	11" (279mm)
Focal Length	2032mm	2350mm	2800mm
F/ratio of the Optical System	10	10	10
Primary Mirror: Material Coatings	Fine Annealed Pyrex Starbright Coatings - 5 step multi-layer process Optional:Starbright XLT Coating	Fine Annealed Pyrex Starbright Coatings - 5 step multi-layer process Optional:Starbright XLT Coating	Fine Annealed Pyrex Starbright Coatings - 5 step multi-layer process Optional:Starbright XLT Coating
Central Obstruction	2.5"	3.35"	3.75"
Corrector Plate: Material Coatings	Optical Quality Crown Glass A-R Coatings both sides	Optical Quality Crown Glass A-R Coatings both sides	Optical Quality Crown Glass A-R Coatings both sides
Highest Useful Magnification	480x (~4mm eyepiece)	555x (~4mm eyepiece)	660x (~4mm eyepiece)
Lowest Useful Magnification (7mm exit pupil)	29x (~70mm eyepiece)	34x (~70mm eyepiece)	40x (~70mm eyepiece)
Magnification: Standard Eyepiece (40mm Pl)	51x	59x	70x
Resolution: Rayleigh Criterion Dawes Limit	.68 arc seconds .57 arc seconds	.59 arc seconds .49 arc seconds	.50 arc seconds .42 arc seconds
Light Gathering Power	843x	1127x	1593x
Near Focus w/ standard eyepiece or camera	~25 feet	~40 feet	~60 feet
Field of View: Standard Eyepiece : 35mm Camera	.9° 1° x .68°	.78° .9° x .6°	.65° .72° x .50°
Linear Field of View (at 1000 yds)	47 ft.	41 ft.	34.5 ft.
Optical Tube Length	17"	22"	23"
Weight of Telescope	42 lbs	58 lbs	65 lbs
Weight of Tripod	19 lbs	19 lbs	19 lbs

Electronic Specifications

Input Voltage Maximum Minimum	12 V DC Nominal 15 V DC Max. 9 V DC Min.
Power Supply Requirements	12 VDC-1.5A (Tip positive)
GPS	Internal 16 channel

Mechanical Specifications

Motor: Type Resolution	DC Servo motors with encoders, both axes .1406 arc sec
Slew speeds	Nine slew speeds: 3°/sec, 2°/sec, .5°/sec, 64x, 16x, 8x, 4x, 1x, .5x
Hand Control	Double line, 16 character Liquid Crystal Display 19 fiber optic backlit LED keypad
Fork Arm	Dual Fork tine cast aluminum with detachable HC holder
Gears	5.625", precision aluminum gears on both axes, 180 tooth. Brass worm gear
Bearings	9.8" Azimuth Bearing
Optical Tube	Aluminum

Software Specifications

Software Precision	24 bit, .08 arc sec. calculations
Ports	RS-232 communication port on hand control, Autoguider Port, 2 Auxiliary Port
Period Error Correction	Permanently programmable
Tracking Rates	Sidereal, Solar, Lunar
Tracking Modes	Alt-Az, EQ North & EQ South
Alignment Procedures	Sky Align, Auto Two-Star Align, Two-Star Align, Solar System Align, EQ North Align & EQ South Align
Database	40,000+ objects, 99 user defined programmable objects. Enhanced information on over 200 objects
Complete Revised NGC Catalog	7,840
Complete Messier Catalog	110
Complete IC Catalog	5,386
Complete Caldwell	109
Abell Galaxies	2,712
Solar System objects	9
Famous Asterisms	20
Selected CCD Imaging Objects	25
Selected SAO Stars	29,500

Appendix B - Glossary of Terms

A-

Absolute magnitude	The apparent magnitude that a star would have if it were observed from a standard distance of 10 parsecs, or 32.6 light-years. The absolute magnitude of the Sun is 4.8. at a distance of 10 parsecs, it would just be visible on Earth on a clear moonless night away from surface light.
Airy disk	The apparent size of a star's disk produced even by a perfect optical system. Since the star can never be focused perfectly, 84 per cent of the light will concentrate into a single disk, and 16 per cent into a system of surrounding rings.
Alt-Azimuth Mounting	A telescope mounting using two independent rotation axis allowing movement of the instrument in Altitude and Azimuth.
Altitude	In astronomy, the altitude of a celestial object is its Angular Distance above or below the celestial horizon.
Aperture	the diameter of a telescope's primary lens or mirror; the larger the aperture, the greater the telescope's light-gathering power.
Apparent Magnitude	A measure of the relative brightness of a star or other celestial object as perceived by an observer on Earth.
Arcminute	A unit of angular size equal to 1/60 of a degree.
Arcsecond	A unit of angular size equal to 1/3,600 of a degree (or 1/60 of an arcminute).
Asterism	A small unofficial grouping of stars in the night sky.
Asteroid	A small, rocky body that orbits a star.
Astrology	The pseudoscientific belief that the positions of stars and planets exert an influence on human affairs; astrology has nothing in common with astronomy.
Astronomical unit (AU)	The distance between the Earth and the Sun. It is equal to 149,597,900 km., usually rounded off to 150,000,000 km.
Aurora	The emission of light when charged particles from the solar wind slams into and excites atoms and molecules in a planet's upper atmosphere.
Azimuth	The angular distance of an object eastwards along the horizon, measured from due north, between the astronomical meridian (the vertical line passing through the center of the sky and the north and south points on the horizon) and the vertical line containing the celestial body whose position is to be measured. .

B -

Binary Stars	Binary (Double) stars are pairs of stars that, because of their mutual gravitational attraction, orbit around a common Center of Mass. If a group of three or more stars revolve around one another, it is called a multiple system. It is believed that approximately 50 percent of all stars belong to binary or multiple systems. Systems with individual components that can be seen separately by a telescope are called visual binaries or visual multiples. The nearest "star" to our solar system, Alpha Centauri, is actually our nearest example of a multiple star system, it consists of three stars, two very similar to our Sun and one dim, small, red star orbiting around one another.
--------------	---

C -

Celestial Equator	The projection of the Earth's equator on to the celestial sphere. It divides the sky into two equal hemispheres.
Celestial pole	The imaginary projection of Earth's rotational axis north or south pole onto the celestial sphere.
Celestial Sphere	An imaginary sphere surrounding the Earth, concentric with the Earth's center.
Collimation	The act of putting a telescope's optics into perfect alignment.

D -

Declination (DEC)	The angular distance of a celestial body north or south of the celestial equator. It may be said to correspond to latitude on the surface of the Earth.
-------------------	---

E -

Ecliptic	The projection of the Earth's orbit on to the celestial sphere. It may also be defined as "the apparent yearly path of the Sun against the stars".
Equatorial mount	A telescope mounting in which the instrument is set upon an axis which is parallel to the axis of the Earth; the angle of the axis must be equal to the observer's latitude.

F -

Focal length	The distance between a lens (or mirror) and the point at which the image of an object at infinity is brought to focus. The focal length divided by the aperture of the mirror or lens is termed the focal ratio.
--------------	--

J - Jovian Planets	Any of the four gas giant planets that are at a greater distance from the sun than the terrestrial planets.
K - Kuiper Belt	A region beyond the orbit of Neptune extending to about 1000 AU which is a source of many short period comets.
L - Light-Year (LY)	A light-year is the distance light traverses in a vacuum in one year at the speed of 299,792 km/ sec. With 31,557,600 seconds in a year, the light-year equals a distance of 9.46 X 1 trillion km (5.87 X 1 trillion mi).
M - Magnitude	Magnitude is a measure of the brightness of a celestial body. The brightest stars are assigned magnitude 1 and those increasingly fainter from 2 down to magnitude 5. The faintest star that can be seen without a telescope is about magnitude 6. Each magnitude step corresponds to a ratio of 2.5 in brightness. Thus a star of magnitude 1 is 2.5 times brighter than a star of magnitude 2, and 100 times brighter than a magnitude 5 star. The brightest star, Sirius, has an apparent magnitude of -1.6, the full moon is -12.7, and the Sun's brightness, expressed on a magnitude scale, is -26.78. The zero point of the apparent magnitude scale is arbitrary.
Meridian	A reference line in the sky that starts at the North celestial pole and ends at the South celestial pole and passes through the zenith. If you are facing South, the meridian starts from your Southern horizon and passes directly overhead to the North celestial pole.
Messier	A French astronomer in the late 1700's who was primarily looking for comets. Comets are hazy diffuse objects and so Messier cataloged objects that were not comets to help his search. This catalog became the Messier Catalog, M1 through M110.
N - Nebula	Interstellar cloud of gas and dust. Also refers to any celestial object that has a cloudy appearance.
North Celestial Pole	The point in the Northern hemisphere around which all the stars appear to rotate. This is caused by the fact that the Earth is rotating on an axis that passes through the North and South celestial poles. The star Polaris lies less than a degree from this point and is therefore referred to as the "Pole Star".
Nova	Although Latin for "new" it denotes a star that suddenly becomes explosively bright at the end of its life cycle.
O - Open Cluster	One of the groupings of stars that are concentrated along the plane of the Milky Way. Most have an asymmetrical appearance and are loosely assembled. They contain from a dozen to many hundreds of stars.
P - Parallax	Parallax is the difference in the apparent position of an object against a background when viewed by an observer from two different locations. These positions and the actual position of the object form a triangle from which the apex angle (the parallax) and the distance of the object can be determined if the length of the baseline between the observing positions is known and the angular direction of the object from each position at the ends of the baseline has been measured. The traditional method in astronomy of determining the distance to a celestial object is to measure its parallax.
Parfocal	Refers to a group of eyepieces that all require the same distance from the focal plane of the telescope to be in focus. This means when you focus one parfocal eyepiece all the other parfocal eyepieces, in a particular line of eyepieces, will be in focus.
Parsec	The distance at which a star would show parallax of one second of arc. It is equal to 3.26 light-years, 206,265 astronomical units, or 30,800,000,000,000 km. (Apart from the Sun, no star lies within one parsec of us.)
Point Source	An object which cannot be resolved into an image because it is too far away or too small is considered a point source. A planet is far away but it can be resolved as a disk. Most stars cannot be resolved as disks, they are too far away.
R - Reflector	A telescope in which the light is collected by means of a mirror.
Resolution	The minimum detectable angle an optical system can detect. Because of diffraction, there is a limit to the minimum angle, resolution. The larger the aperture, the better the resolution.
Right Ascension: (RA)	The angular distance of a celestial object measured in hours, minutes, and seconds along the Celestial Equator eastward from the Vernal Equinox.
S - Schmidt Telescope	Rated the most important advance in optics in 200 years, the Schmidt telescope combines the best features of the refractor and reflector for photographic purposes. It was invented in 1930 by Bernhard Voldemar Schmidt (1879-1935).
Sidereal Rate	This is the angular speed at which the Earth is rotating. Telescope tracking motors drive the

telescope at this rate. The rate is 15 arc seconds per second or 15 degrees per hour.

T -

Terminator

The boundary line between the light and dark portion of the moon or a planet.

U -

Universe

The totality of astronomical things, events, relations and energies capable of being described objectively.

V -

Variable Star

A star whose brightness varies over time due to either inherent properties of the star or something eclipsing or obscuring the brightness of the star.

W -

Waning Moon

The period of the moon's cycle between full and new, when its illuminated portion is decreasing.

Waxing Moon

The period of the moon's cycle between new and full, when its illuminated portion is increasing.

Z -

Zenith

The point on the Celestial Sphere directly above the observer.

Zodiac

The zodiac is the portion of the Celestial Sphere that lies within 8 degrees on either side of the Ecliptic. The apparent paths of the Sun, the Moon, and the planets, with the exception of some portions of the path of Pluto, lie within this band. Twelve divisions, or signs, each 30 degrees in width, comprise the zodiac. These signs coincided with the zodiacal constellations about 2,000 years ago. Because of the Precession of the Earth's axis, the Vernal Equinox has moved westward by about 30 degrees since that time; the signs have moved with it and thus no longer coincide with the constellations.

APPENDIX C LONGITUDES AND LATITUDES

	LONGITUDE		LATITUDE	
	degrees	min	degrees	min
ALABAMA				
Anniston	85	51	33	34.8
Auburn	85	26.4	32	40.2
Birmingham	86	45	33	34.2
Centreville	87	15	32	54
Dothan	85	27	31	19.2
Fort Rucker	85	43.2	31	16.8
Gadsden	86	5.4	33	58.2
Huntsville	86	46.2	34	39
Maxwell AFB	86	22.2	32	22.8
Mobile	88	15	30	40.8
Mobile Aeros	88	4.2	30	37.8
Montgomery	86	2.4	32	18
Muscle Shoals	87	37.2	34	45
Selma	86	59.4	32	20.4
Troy	86	1.2	31	52.2
Tuscaloosa	87	37.2	33	13.8
ALASKA				
Anchorage	149	51	61	13.2
Barrow	156	46.8	71	18
Fairbanks	147	52.2	64	49.2
Haines Hrbor	135	25.8	59	13.8
Homer	151	3	59	37.8
Juneau	134	34.8	58	22.2
Ketchikan	131	4.2	55	21
Kodiak	152	3	57	45
Nome	165	25.8	64	30
Sitka	135	21	57	4.2
Sitkinak	154	1.2	56	52.8
Skagway	135	31.8	59	45
Valdez	146	21	61	7.8
ARIZONA				
Davis-M AFB	110	52.8	32	10.2
Deer Valley	112	4.8	33	40.8
Douglas	109	3.6	31	27
Falcon Fld	111	43.8	33	28.2
Flagstaff	111	40.2	35	7.8
Fort Huachuc	110	21	31	36
Gila Bend	113	10.2	33	33
Goodyear	112	22.8	33	25.2
GrandCanyon	112	9	35	57
Kingman	113	57	35	16.2
Luke	112	22.8	33	31.8
Page	111	27	36	55.8
Payson	111	19.8	34	13.8
Phoenix	112	1.2	33	25.8
Prescott	112	25.8	34	39
Safford Awrs	109	40.8	32	49.2
Scottsdale	111	55.2	33	37.2
Show Low	110	0	34	16.2
Tucson	110	55.8	32	7.2
Williams AFB	111	40.2	33	18
Winslow	110	43.8	35	1.2
Yuma	115	0	33	6
Yuma Mcas	114	37.2	32	39
Yuma Prv Gd	114	2.4	32	51
ARKANSAS				
Blytheville	89	57	35	58.2
Camden	92	2.4	33	31.2
El Dorado	92	4.8	33	13.2
Fayetteville	94	10.2	36	0
Ft Smith	94	22.2	35	19.8
Harrison	93	9	36	16.2
Hot Springs	93	0.6	34	28.8
Jonesboro	90	39	35	49.8
Little Rock	92	22.8	35	13.2
Pine Bluff	91	55.8	34	10.2
Springdale	94	7.8	36	10.8
Texarkana	94	0	33	27
Walnut Ridge	90	55.8	36	7.8
CALIFORNIA				
Alameda	122	19.2	37	46.8
Alturas	120	31.8	41	28.8
Arcata	124	0.6	40	58.8
Bakersfield	119	3	35	25.8
Beale AFB	121	27	39	7.8
Beaumont	116	57	33	55.8
Bicycle Lk	116	37.2	35	16.8
Big Bear	116	40.8	34	16.2
Bishop	118	3.6	37	36
Blue Canyon	120	4.2	39	16.8

	LONGITUDE		LATITUDE	
	degrees	min	degrees	min
Blythe	114	43.2	33	37.2
Burbank	118	22.2	34	12
Campo	116	28.2	32	37.2
Carlsbad	117	16.8	33	7.8
Castle AFB	120	34.2	37	22.8
Chico	121	51	39	46.8
China Lake	117	40.8	35	40.8
Chino	117	37.8	33	58.2
Concord	122	3	37	58.8
Crescent Cty	124	13.8	41	46.8
Daggett	116	46.8	34	52.2
Edwards AFB	117	52.8	34	54
El Centro	115	40.8	32	49.2
El Monte	118	1.8	34	4.8
El Toro	117	43.8	33	40.2
Eureka	124	16.8	41	19.8
Fort Hunter	121	19.2	36	0
Fort Ord	121	46.2	36	40.8
Fresno	119	43.2	36	46.2
Fullerton	117	58.2	33	52.2
George AFB	117	22.8	34	34.8
Hawthorne	118	19.8	33	55.2
Hayward	122	7.2	37	39
Imperial	115	34.2	32	49.8
Imperial Bch	117	7.2	32	34.2
La Verne	117	46.8	34	6
Lake Tahoe	120	0	38	54
Lancaster	118	13.2	34	43.8
Livermore	121	49.2	37	42
Long Beach	118	9	33	49.2
Los Alamitos	118	3	33	46.8
Los Angeles	118	2.4	33	55.8
Mammoth	118	55.2	37	37.8
March AFB	117	16.2	33	52.8
Marysville	121	34.2	39	6
Mather AFB	121	1.8	38	34.2
Mcclellan	121	2.4	38	40.2
Merced	120	31.2	37	16.8
Miramar NAS	117	9	32	52.2
Modesto	120	57	37	37.8
Moffet	122	3	37	25.2
Mojave	118	9	35	3
Montague	122	31.8	41	43.8
Monterey	121	51	36	34.8
Mount Shasta	122	19.2	41	19.2
Mount Wilson	118	4.2	34	13.8
Napa	122	16.8	38	13.2
Needles	114	37.2	34	46.2
North Is	117	1.2	32	42
Norton AFB	117	13.8	34	6
Oakland	122	13.2	37	43.8
Ontario Intl	117	37.2	34	3
Oxnard	119	1.2	34	12
Palm Springs	116	3	33	49.8
Palmdale	118	7.8	35	3
Palo Alto	122	7.2	37	28.2
Paso Robles	120	37.8	35	40.2
Pillaro Pt	122	49.8	37	49.8
Point Mugu	119	7.2	34	7.2
Pt Arena	124	13.2	39	34.8
Pt Arguello	121	7.2	34	57
Pt Piedras	121	16.8	35	40.2
Red Bluff	122	15	40	9
Redding	122	1.8	40	30
Riverside	117	27	33	57
Sacramento	121	3	38	31.2
Salinas	121	3.6	36	40.2
San Carlos	122	15	37	31.2
San	117	37.2	33	25.2
Clemente				
San Diego	117	7.8	32	49.2
San	122	22.8	37	37.2
Francisco				
San Jose	121	55.2	37	22.2
San Luis Obi	120	39	35	13.8
San Mateo	117	34.8	33	22.8
San Miguel	120	2.4	34	1.8
Sandburg	118	43.8	34	45
Santa Ana	117	52.8	33	40.2
Santa Barb	119	49.8	34	25.8
Santa Maria	120	27	34	54
Santa Monica	118	27	34	1.2
Santa Rosa	122	49.2	38	31.2

	LONGITUDE		LATITUDE	
	degrees	min	degrees	min
Shelter Cove	124	4.2	40	1.8
Siskiyou	122	28.2	41	46.8
Stockton	121	15	37	54
Superior Val	117	0.6	35	19.8
Susanville	120	57	40	37.8
Thermal	116	10.2	33	37.8
Torrance	118	19.8	33	48
Travis AFB	121	55.8	38	16.2
Tahoe	120	7.8	39	19.2
Tustin Mcas	117	49.8	33	42
Ukiah	123	1.2	39	7.8
Van Nuys	118	28.8	34	13.2
Vandenberg	120	57	35	12
Visalia	119	2.4	36	19.2
COLORADO				
Air Force A	105	21	39	31.2
Akron	103	13.2	40	10.2
Alamosa	105	52.2	37	27
Aspen	106	52.2	39	13.2
Brmfield/Jef	105	7.2	39	54
Buckley	104	45	39	43.2
Colo Sprgs	104	43.2	38	49.2
Cortez	108	37.8	37	18
Craig-Moffat	107	31.8	40	30
Denver	104	52.2	39	45
Durango	107	45	37	9
Eagle	106	55.2	39	39
Englewood	104	49.8	39	34.2
Fort Carson	104	46.2	38	40.8
Fraser	105	3	39	34.2
Ft Col/Lovel	105	1.2	40	27
Ft Collins	105	4.8	40	34.8
Grand Jct	108	31.8	39	7.2
Greeley-Wld	104	37.8	40	25.8
Gunnison	106	55.8	38	33
La Junta	103	31.2	38	3
Lamar	102	3.6	38	7.2
Leadville	106	1.8	39	15
Limon	103	4.2	39	10.8
Montrose	107	52.8	38	30
Pueblo	104	31.2	38	16.8
Rifle	107	4.8	39	31.8
Salida	106	3	38	31.8
Trinidad	104	19.8	37	15
Winter Park	105	52.2	40	0
CONNECTICUT				
Bridgeport	73	7.8	41	10.2
Danbury	73	28.8	41	22.2
Groton	72	3	41	19.8
Hartford	72	39	41	43.8
New Haven	72	40.2	41	13.2
New London	72	4.8	41	18
Windsor Loc	72	40.8	41	55.8
DELAWARE				
Dover	75	28.2	39	7.8
Wilmington	75	3.6	39	40.2
D.C. WASH				
Washington	77	27.6	38	57
FLORIDA				
Apalachicola	85	1.8	29	43.8
Astor NAS	81	34.2	29	7.2
Avon Park G	81	33	28	4.8
Cape	80	33	28	28.2
Canaveral				
Cecil	81	52.8	30	13.2
Crestview	86	31.2	30	46.8
Cross City	83	0.6	29	37.2
Daytona Bch	81	3	29	10.8
Duke Fld	86	31.2	30	39
Eglin AFB	86	31.8	30	28.8
Egmont Key	82	46.2	27	36
Fort Myers	81	52.2	26	34.8
Ft Lauderdale	80	9	26	4.2
Ft Myers	81	52.2	26	39
Gainesville	82	16.2	29	40.8
Homestead	80	2		

	LONGITUDE		LATITUDE	
	degrees	min	degrees	min
Melbourne	80	37.8	28	6
Miami	80	16.8	25	49.2
Naples	81	4.8	26	7.8
Nasa Shuttle	80	40.8	28	37.2
Orlando	81	19.2	28	25.8
Panama City	85	40.8	30	12
Patrick AFB	80	3.6	28	13.8
Pensacola	87	19.2	30	21
Ruskin	82	3.6	27	58.2
Saint Peters	82	40.8	27	55.2
Sanford	81	15	28	46.8
Sarasota	82	33	27	24
Tallahassee	84	22.2	30	22.8
Tampa Intl	82	31.8	27	58.2
Titusville	80	4.8	28	31.2
Tyndall AFB	85	34.8	30	4.2
Vero Beach	80	25.2	27	39
West Palm Beach	80	7.2	26	40.8
Whiting Fld	87	1.2	30	43.2
GEORGIA				
Albany	84	10.8	31	31.8
Alma	82	31.2	31	31.8
Athens	83	19.2	33	57
Atlanta	84	25.2	33	39
Augusta/Bush	81	58.2	33	22.2
Brunswick	81	22.8	31	9
Columbus	84	55.8	32	31.2
Dobbins AFB	84	31.2	33	55.2
Fort Benning	85	0	32	19.8
Ft Stewart	81	34.2	31	52.8
Hunter Aaf	81	9	32	1.2
La Grange	85	4.2	33	0.6
Macon/Lewis	83	39	32	42
Moody AFB	83	1.2	30	58.2
Robins AFB	83	3.6	32	37.8
Rome/Russell	85	10.2	34	21
Valdosta	83	16.8	30	46.8
Waycross	82	2.4	31	15
HAWAII				
Barbers Pt	158	7.2	21	31.8
Barking San Fr Frigate	160	1.8	22	3
Hilo	155	4.2	19	43.2
Honolulu Int	157	55.8	21	21
Kahului Maui	156	25.8	20	54
Kaneohe Mca	158	16.8	21	45
Kilauea Pt	159	40.2	22	22.8
Lanai-Lanai	156	57	20	48
Lihue-Kauai	159	21	21	58.8
Maui	156	49.8	20	58.2
Molokai	157	0.6	21	9
Upolo Pt Ln	156	28.2	20	25.2
Waimea-Koha	156	7.2	20	0
IDAHO				
Boise	116	13.2	43	34.2
Burley	113	46.2	42	31.8
Challis	114	13.2	44	31.2
Coeur d'Alene	116	49.2	47	46.2
Elk City	115	25.8	45	49.2
Gooding	115	10.2	43	0
Grangeville	116	7.8	45	55.2
Idaho Falls	112	4.2	43	31.2
Lewiston	117	1.2	46	22.8
Malad City	112	19.2	42	10.2
Malta	113	22.2	42	18
Mccall	116	0.6	44	52.8
Mullan	115	4.8	47	28.2
Pocatello	112	3.6	42	55.2
Salmon	113	5.4	45	10.8
Soda Springs	111	34.8	42	39
Sun Valley	114	1.8	43	30
Twin Falls	114	28.8	42	28.8
ILLINOIS				
Alton	90	3	38	52.8
Aurora	88	19.2	41	46.2
Bistate Park	90	9	38	34.2
Bloomington	88	55.8	40	28.8
Bradford	89	3.6	41	9.6
Cairo	89	13.2	37	4.2
Carbondale	89	15	37	46.8
Centralia	89	5.4	38	30.6
Champaign	88	16.8	40	1.8
Chicago	87	39	41	54
Danville	87	3.6	40	12
DeKalb	88	43.2	41	55.8
Decatur	88	52.2	39	49.8
Du Page	88	15	41	55.2
Galesburg	90	25.8	40	55.8

	LONGITUDE		LATITUDE	
	degrees	min	degrees	min
Glenview	87	49.2	42	4.8
NAS				
Kankakee	87	51	41	4.2
Macomb	90	39.6	40	31.2
Marion	89	0	37	45
Marseilles	88	40.8	41	22.2
Mattoon	88	16.8	39	28.8
Moline/Quad	90	31.2	41	27
Mount Vernon	88	51.6	38	19.2
Peoria	89	40.8	40	40.2
Quincy	91	1.2	39	55.8
Rockford	89	0.6	42	12
Salem	88	57.6	38	37.8
Scott AFB	89	51	38	33
Springfield	89	40.2	39	51
Sterling	89	40.2	41	44.4
Taylorville	89	19.8	39	31.8
Vandalia	89	10.2	38	59.4
INDIANA				
Bakalar	86	3	39	22.8
Bloomington	86	37.2	39	7.8
Elkhart	86	0	41	43.2
Evansville	87	31.8	38	3
Fort Wayne	85	1.2	41	0
Gary	87	25.2	41	37.2
Grissom AFB	86	9	40	39
Indianapolis	86	16.2	39	43.8
Muncie	85	22.8	40	13.8
South Bend	86	19.2	41	42
Terre Haute	87	1.8	39	27
W Lafayette	86	55.8	40	25.2
IOWA				
Burlington	91	7.2	40	46.8
Cedar Rapids	91	4.2	41	52.8
Des Moines	93	39	41	31.8
Dubuque	90	4.2	42	24
Estherville	94	45	43	24
Fort Dodge	94	10.8	42	33
Lamoni	93	55.8	40	37.2
Mason City	93	19.8	43	9
Ottumwa	92	27	41	6
Sioux City	96	22.8	42	24
Spencer	95	9	43	10.2
Waterloo Mun	92	2.4	42	33
KANSAS				
Chanute	95	28.8	37	40.2
Col. J Jabar	97	13.2	37	45
Concordia	97	39	39	33
Dodge City	99	58.2	37	46.2
Elkhart	101	52.8	37	0
Emporia	96	1.2	38	19.8
Ft Leavenwrth	94	55.2	39	22.2
Ft Riley	96	46.2	39	3
Garden City	100	43.2	37	55.8
Goodland	101	4.2	39	22.2
Hays	99	16.2	38	51
Hill City	99	49.8	39	22.8
Hutchinson	97	52.2	38	4.2
Johnson Cnty	94	52.8	38	49.2
Liberal	100	58.2	37	3
Manhattan	96	40.2	39	9
Mcconnell Af	97	16.2	37	37.2
Medicine Ldg	98	34.8	37	18
Olathe	94	5.4	38	51
Russell	98	49.2	38	52.2
Salina	97	39	38	48
Topeka	95	37.2	39	4.2
Topeka/Forbe	95	40.2	38	57
Wichita	97	25.8	37	39
KENTUCKY				
Bowling Gren	86	25.8	36	58.2
Ft Campbell	87	3	36	40.2
Ft Knox	85	58.2	37	54
Jackson	83	19.2	37	36
Lexington	85	0	38	3
London	84	4.2	37	4.8
Louisville	85	40.2	38	13.8
Owensboro	87	10.2	37	45
Paducah	88	46.2	37	4.2
Pikeville	82	31.2	37	28.8
LOUISIANA				
Alexandria	92	1.8	31	22.8
Barksdale	93	40.2	32	30
Baton Rouge	91	9	30	31.8
Boothville	89	40.2	29	33
Cameron Heli	93	1.8	29	46.8
Claiborne R	92	57	31	13.2
England AFB	92	33	31	19.8
Eugene Is.	91	46.8	28	28.2
Fort Polk	93	1.2	31	3

	LONGITUDE		LATITUDE	
	degrees	min	degrees	min
Grand Isle	90	4.2	29	10.8
High Island	94	2.4	28	7.8
Houma	90	39	29	34.2
Intercoastal	92	7.2	29	43.8
Lafayette	92	0	30	12
Lake Charles	93	13.2	30	7.2
Lk Palourde	91	0.6	29	42
Missippi Can	89	3	28	46.8
Monroe	92	3	32	31.2
Morgan City	91	1.2	29	42
New Iberia	91	52.8	30	1.8
New Orleans	90	15	29	58.8
S Marsh Isl	91	58.8	28	18
Shreveport	93	45	32	31.2
Slidel	89	49.2	30	21
MAINE				
Augusta	69	4.8	44	19.2
Bangor	68	49.2	44	48
Bar Harbor	68	22.2	44	27
Brunswick	69	55.8	43	52.8
Caribou Mun	68	1.2	46	52.2
Greenville	69	33	45	27
Houlton	67	46.8	46	7.8
Loring AFB	67	52.8	46	57
Portland	70	19.2	43	39
Presque Isle	68	3	46	40.8
Rockland	69	7.2	44	4.2
Rumford	70	52.8	44	52.8
MARYLAND				
Andrews AFB	76	52.2	38	49.2
Baltimore	76	40.2	39	10.8
Fort Meade	76	46.2	39	4.8
Hagerstown	77	43.2	39	42
Ocean City	75	7.8	38	33
Patuxent	76	2.4	38	16.8
Phillips	76	10.2	39	28.2
Salisbury	75	3	38	19.8
MASSACHUSETTS				
Bedford	71	16.8	42	28.2
Beverly	70	55.2	42	34.8
Boston	71	1.8	42	22.2
Cape Cod	70	3	41	46.8
Chatham	69	58.2	41	40.2
Fort Devens	71	3.6	42	34.2
Hyannis	70	16.8	41	40.2
Lawrence	71	7.2	42	43.2
Marthas Vine	70	37.2	41	24
Nantucket	70	4.2	41	15
New Bedford	70	58.2	41	40.8
Norwood	71	10.8	42	10.8
Otis ANGB	70	31.2	41	39
Pittsfield	73	10.8	42	15.6
S Weymouth	70	55.8	42	9
Westfield	72	43.2	42	10.2
Westover	72	31.8	42	12
Worcester	71	52.2	42	16.2
MICHIGAN				
Alpena	83	34.2	45	4.2
Ann Arbor	83	45	42	13.2
Battle Creek	85	13.8	42	18
Benton Harbor	86	25.8	42	7.8
Chippewa	84	28.2	46	15
Coopersville	85	57	43	4.2
Copper Harb	87	51	47	28.2
Detroit	83	1.2	42	25.2
Escanaba	87	4.8	45	43.8
Flint/Bishop	83	45	42	58.2
Grand Rapids	85	31.2	42	52.8
Hancock	88	3	47	10.2
Harbor Beach	82	31.8	43	49.8
Houghton Lake	84	40.8	44	22.2
Iron Mtn	88	7.2	45	49.2
Ironwood	90	7.8	46	31.8
Jackson	84	28.2	42	16.2
Kalamazoo	85	33	42	13.8
Lansing	84	3.6	42	46.2
Manistee	86	15	44	16.2
Marquette	87	57	46	52.8
Menominee	87	37.8	45	7.2
Muskegon	86	15	43	10.2
Pellston	84	4.8	45	34.2
Pontiac	83	25.2	42	40.2
Saginaw	84	4.8	43	31.8
Sault Ste M	84	22.2	46	28.2
Sawyer AFB	87	2.4	46	21
Selfridge	82	49.8	42	37.2
Seul Choix	85	55.2	45	55.2
Traverse Cty	85	34.8	44	43.8

	LONGITUDE		LATITUDE	
	degrees	min	degrees	min
Wurtsmith	83	2.4	44	27
Ypsilanti	83	31.8	42	13.8
MINNESOTA				
Albert Lea	93	22.2	43	40.8
Alexandria	95	22.8	45	52.2
Bemidji Muni	94	55.8	47	30
Brainerd-Crw	94	7.8	46	24
Detroit Laks	95	52.8	46	49.2
Duluth	92	10.8	46	49.8
Ely	91	49.2	47	54
Fairmont	94	25.2	43	39
Fergus Falls	96	4.2	46	18
Grand Rapids	93	31.2	47	13.2
Hibbing	92	51	47	22.8
Intl Falls	93	22.8	48	34.2
Litchfield	94	31.2	45	7.8
Mankato	93	55.2	44	13.2
Marshall Arpt	95	49.2	44	27
Minneapolis	93	28.2	44	49.8
Park Rapids	95	4.2	46	54
Pequot Lake	94	19.2	46	36
Rochester	92	3	43	55.2
Saint Paul	93	3	44	55.8
St Cloud	94	4.2	45	33
Thief River	96	10.8	48	4.2
Tofte	90	49.8	47	34.8
Warroad	95	21	48	55.8
Worthington	95	34.8	43	39
MISSISSIPPI				
Columbus	88	27	33	39
AFB				
Golden Trian	88	34.8	33	27
Greenville	90	58.8	33	28.8
Greenwood	90	4.8	33	30
Gulfport	89	4.2	30	24
Hattiesburg	89	19.8	31	28.2
Jackson	90	4.8	32	19.2
Keesler AFB	88	55.2	30	25.2
Laurel	89	10.2	31	40.2
Mccomb	90	28.2	31	10.8
Meridian NAS	88	34.2	32	33
Meridian/Key	88	45	32	19.8
Natchez	91	15	31	37.2
Oxford	89	32.4	34	23.4
Tupelo	88	46.2	34	16.2
MISSOURI				
Columbia	92	13.2	38	49.2
Cape	89	34.8	37	13.8
Girardeau				
Ft Leonard	92	7.8	37	45
Jefferson City	92	10.2	38	36
Joplin	94	3	37	10.2
Kansas City	94	43.2	39	19.2
Kirksville	92	33	40	6
Monett	94	21	37	19.8
Muskogee	95	21.6	35	39.6
Poplar Bluff	90	28.2	36	46.2
Richards-Geb	94	33	38	51
Spickard	93	43.2	40	15
Springfield	93	22.8	37	13.8
St Joseph	95	31.8	40	16.8
St Louis	90	22.2	38	45
Vichy/Rolla	91	46.2	38	7.8
West Plains	92	25.2	37	13.2
Whiteman	93	33	38	43.8
AFB				
MONTANA				
Billings	108	31.8	45	48
Bozeman	111	9	45	46.8
Broadus	105	40.2	45	40.2
Butte	112	3	45	57
Cut Bank	112	22.2	48	36
Dillon	112	33	45	15
Drummond	113	9	46	40.2
Glasgow	106	37.2	48	13.2
Glendive	104	4.8	47	7.8
Great Falls	111	22.2	47	28.8
Harlowton	109	49.8	46	25.8
Havre	109	46.2	48	33
Helena	112	0	46	36
Jordan	106	55.8	47	19.8
Kalispell	114	16.2	48	18
Lewiston	109	27	47	3
Livingston	110	25.8	45	42
Malmstrom	111	10.8	47	30
Miles City	105	52.2	46	25.8
Missoula	114	4.8	46	55.2
Monida	112	19.2	44	34.2
Sidney	104	10.8	47	43.2
W Yellowstone	111	0.6	44	39

	LONGITUDE		LATITUDE	
	degrees	min	degrees	min
NEBRASKA				
Ainsworth	99	58.8	42	34.8
Alliance	102	4.8	42	3
Beatrice	96	45	40	19.2
Broken Bow	99	39	41	25.8
Burwell	99	9	41	46.8
Chadron	103	4.8	42	49.8
Columbus	97	21	41	27
Cozad	100	0	40	52.2
Falls City	95	34.8	40	4.2
Grand Island	98	19.2	40	58.2
Hastings	98	25.8	40	36
Imperial	101	23.4	40	19.8
Kearney	99	0	40	43.8
Lincoln Muni	96	45	40	51
Mccook	100	34.8	40	13.2
Mullen	101	3	42	3
Norfolk	97	25.8	41	58.8
North Omaha	96	1.2	41	22.2
North Platte	100	40.8	41	7.8
O'Neill	98	40.8	42	28.2
Offutt AFB	95	55.2	41	7.2
Omaha	95	5.4	41	18
Ord/Sharp	98	57	41	37.2
Scottsbluff	103	3.6	41	52.2
Sidney Muni	102	58.8	41	6
Valentine	100	33	42	52.2
NEVADA				
Austin	117	7.8	39	49.8
Battle Mtn	116	52.2	40	37.2
Caliente	114	31.2	37	37.2
Elko	115	46.8	40	49.8
Ely/Yelland	114	51	39	16.8
Eureka	115	58.2	39	30
Fallon NAS	118	4.2	39	25.2
Hawthorne	118	37.8	38	33
Ind Sprng Rn	115	34.2	36	31.8
Las Vegas	115	10.2	36	4.8
Lovelock	118	55.2	40	6
Mercury	116	1.2	36	37.2
Nellis AFB	115	1.8	36	13.8
Owyhee	116	10.2	42	34.8
Reno	119	46.8	39	30
Tonopah	117	4.8	38	4.2
Wildhorse	116	15	41	19.8
Winnemucca	117	4.8	40	54
Yucca Flat	116	4.8	37	34.8
NEW HAMPSHIRE				
Berlin	71	10.8	44	34.8
Concord	71	3	43	12
Jaffrey	72	0	42	48
Keene	72	16.2	42	54
Laconia	71	25.8	43	34.2
Lebanon	72	1.8	43	37.8
Manchester	71	25.8	42	55.8
Mt Washington	71	1.8	44	16.2
Nashua	71	31.2	42	46.8
Pease AFB	70	49.2	43	4.8
Wolfeboro	71	22.8	44	0
NEW JERSEY				
Atlantic Cty	74	34.2	39	27
Barnegat Ls	74	16.8	40	16.8
Fairfield	74	16.8	40	52.2
Lakehurst	74	21	40	1.8
Mcguire AFB	74	3.6	40	1.2
Millville	75	4.2	39	22.2
Morristown	74	25.2	40	48
Newark Intl	74	10.2	40	42
Teterboro	74	3	40	51
Trenton	74	49.2	40	16.8
NEW MEXICO				
Albuquerque	106	3.6	35	3
Cannon	103	19.2	34	22.8
Carlsbad	104	16.2	32	19.8
Clayton Arpt	103	9	36	27
Corona	105	40.8	34	6
Deming	107	4.2	32	15
Farmington	108	13.8	36	45
Gallup/Clark	108	46.8	35	31.2
Grants	107	5.4	35	10.2
Hobbs	103	1.2	32	40.8
Holloman	106	0.6	32	51
AFB				
Las Cruces	106	46.2	32	18
Las Vegas	105	9	35	39
Los Alamos	106	16.8	35	52.8
Moriarity	106	3	34	58.8
Northrup Str	106	2.4	32	54
Raton	104	3	36	44.4
Roswell	104	31.8	33	18

	LONGITUDE		LATITUDE	
	degrees	min	degrees	min
Santa Fe	106	4.8	35	37.2
Silver City	108	10.2	32	37.8
Socorro	106	5.4	34	4.2
Taos	105	34.2	36	25.2
Truth Or Con	107	16.2	33	13.8
Tucumcari	103	3.6	35	10.8
White Sands	106	2.4	32	37.8
NEW YORK				
Albany	73	4.8	42	45
Ambrose	74	22.2	40	45
Binghamton	75	58.8	42	13.2
Buffalo	78	43.8	42	55.8
Dansville	78	1.2	42	58.2
Elmira	76	5.4	42	10.2
Farmingdale	73	25.8	40	43.8
Fort Drum	75	43.8	44	3
Glens Falls	73	37.2	43	21
Griffiss AFB	75	2.4	43	13.8
Islip	73	0.6	40	46.8
Ithaca	76	28.2	42	28.8
Jamestown	79	15	42	9
Massena	74	51	44	55.8
Monticello	74	4.8	41	42
New York	73	58.8	40	46.2
Newburgh	74	0.6	41	30
Niagara Fall	78	57	43	6
Ogdensburg	75	2.4	44	40.8
Oneonta	75	7.2	42	52.2
Plattsburgh	73	28.2	44	39
Rochester	77	40.2	43	7.2
Saranac Lk	74	1.2	44	22.8
Schenectady	73	55.8	42	51
Syracuse	76	7.2	43	7.2
Utica	75	22.8	43	9
Watertown	76	1.2	44	0
Westhampton	72	37.8	40	51
White Plains	73	43.2	41	4.2
NORTH CAROLINA				
Asheville	82	33	35	25.8
Cape Hattera	75	33	35	16.2
Charlotte	80	55.8	35	13.2
Cherry Point	76	52.8	34	54
Dare Co Gr	76	3	36	7.8
Diamond Sho	75	3	35	15
Elizabeth	76	10.8	36	16.2
Fayetteville	78	52.8	35	0
Fort Bragg	78	55.8	35	7.8
Greensboro	79	57	36	4.8
Hickory	81	22.8	35	45
Hot Springs	82	49.2	35	54
Jacksonville	77	37.2	34	49.2
Kinston	77	37.8	35	19.2
Mackall Aaf	79	3	35	1.8
Manteo Arpt	75	40.8	35	55.2
New Bern	77	3	35	4.8
New River	77	25.8	34	42
Pope AFB	79	1.2	35	10.2
Raleigh-Durh	78	46.8	35	52.2
Rocky Mt	77	52.8	35	51
Southern Pin	79	23.4	35	14.4
Wilmington	77	55.2	34	16.2
Winston-Salem	80	13.8	36	7.8
NORTH DAKOTA				
Bismarck	100	45	46	46.2
Devil's Lake	98	5.4	48	7.2
Dickenson	102	4.8	46	46.8
Fargo	96	4.8	46	54
Grand Forks</				

	LONGITUDE		LATITUDE	
	degrees	min	degrees	min
OKLAHOMA				
Altus AFB	99	16.2	34	40.2
Ardmore	97	1.2	34	18
Bartlesville	96	0	36	45
Clinton	99	1.2	35	21
Enid	97	4.8	36	22.8
Fort Sill	98	2.4	34	39
Gage	99	46.2	36	18
Hobart	99	3	35	0
Lawton	98	25.2	34	34.2
Mcalester	95	46.8	34	52.8
Norman	97	28.2	35	13.8
Oklahoma	97	3.6	35	24
Page	94	37.2	34	40.8
Ponca City	97	0.6	36	43.8
Stillwater	97	5.4	36	9.6
Tinker AFB	97	22.8	35	25.2
Tulsa	95	5.4	36	12
Vance AFB	97	55.2	36	19.8
OREGON				
Astoria	123	52.8	46	9
Aurora	122	45	45	15
Baker	117	49.2	44	49.8
Brookings	124	28.2	42	4.8
Burns Arprt	118	57	43	36
Cape Blanco	124	57	43	22.8
Cascade	121	52.8	45	40.8
Corvallis	123	16.8	44	30
Eugene	123	13.2	44	7.2
Hillsboro	122	57	45	31.8
Klamath Fall	121	43.8	42	9
La Grande	118	0	45	16.8
Lake View	120	21	42	10.8
Meacham	118	2.4	45	30
Medford	122	52.2	42	22.2
Newport	124	3	44	37.8
North Bend	124	15	43	25.2
Ontario	117	1.2	44	1.2
Pendleton	118	51	45	40.8
Portland	122	3.6	45	36
Redmond	121	9	44	16.2
Roseburg	123	22.2	43	13.8
Salem	123	0	44	55.2
Sexton	123	22.2	42	37.2
The Dalles	121	9	45	37.2
Troutdale	122	2.4	45	33
PENNSYLVANIA				
Allentown	75	25.8	40	39
Altoona	78	19.2	40	18
Beaver Falls	80	19.8	40	45
Blairsville	79	5.4	40	16.2
Bradford	78	37.8	41	48
Dubois	78	5.4	41	10.8
Erie	80	10.8	42	4.8
Franklin	79	52.2	41	22.8
Harrisburg	76	51	40	13.2
Johnstown	78	49.8	40	19.2
Lancaster	76	1.8	40	7.8
Latrobe	79	2.4	40	16.8
Middletown	76	46.2	40	12
Muir	76	34.2	40	25.8
Nth Philadel	75	1.2	40	4.8
Philadelphia	75	15	39	52.8
Philipsburg	78	7.8	41	28.2
Pittsburgh	79	55.8	40	21
Reading	75	58.2	40	22.8
Site R	77	25.8	39	43.8
State Colleg	77	49.8	40	51
Wilkes-Barre	75	43.8	41	19.8
Williamsport	76	55.2	41	15
Willow Grove	75	9	40	12
RHODE ISLAND				
Block Island	71	34.8	41	10.2
Nth Kingston	71	25.2	41	36
Providence	71	25.8	41	43.8
SOUTH CAROLINA				
Anderson	82	43.2	34	30
Beaufort	80	43.2	32	28.8
Charleston	80	1.8	32	54
Columbia	81	7.2	33	57
Florence	79	43.2	34	10.8
Greenville	82	21	34	51
Mcentire	80	4.8	33	55.2

	LONGITUDE		LATITUDE	
	degrees	min	degrees	min
Myrtle Beach	78	55.8	33	40.8
Shaw AFB	80	28.2	33	58.2
Spartanburg	81	57.6	34	55.2
SOUTH DAKOTA				
Aberdeen	98	25.8	45	27
Brookings	96	4.8	44	18
Chamberlain	99	19.2	43	48
Custer	103	3.6	43	46.2
Ellsworth	103	0.6	44	9
Huron	98	13.2	44	22.8
Lemmon	102	10.2	45	55.8
Mitchell	98	1.8	43	46.2
Mobridge	100	25.8	45	31.8
Philip	101	3.6	44	3
Pierre	100	16.8	44	22.8
Rapid City	103	4.2	44	3
Redig	103	19.2	45	9.6
Sioux Falls	96	43.8	43	34.8
Watertown	97	9	44	55.2
Yankton	97	22.8	42	55.2
TENNESSEE				
Bristol	82	2.4	36	28.8
Chattanooga	85	1.2	35	1.8
Clarksville	87	25.2	36	37.2
Crossville	85	4.8	35	57
Dyersburg	89	2.4	36	1.2
Jackson	88	55.2	35	36
Knoxville	83	58.8	35	49.2
Memphis Intl	90	0	35	3
Monteagle	85	30.6	35	9
Nashville	86	40.8	36	7.2
Smyrna	86	3	36	0
TEXAS				
Abilene	99	40.8	32	25.2
Alice	98	1.8	27	43.8
Amarillo	101	4.2	35	13.8
Austin	97	4.2	30	18
Bergstrom Af	97	40.8	30	12
Big Sky	101	28.8	32	23.4
Big Spring	101	27	32	18
Brownsville	97	25.8	25	54
Brownwood	98	57.6	31	47.4
Carswell AFB	97	25.8	32	46.8
Chase NAS	97	40.2	28	22.2
Childress	100	16.8	34	25.8
College Strn	96	22.2	30	34.8
Corpus Chrst	97	3	27	46.2
Cotulla	99	13.2	28	27
Dalhart	102	33	36	1.2
Dallas/FW	97	1.8	32	54
Del Rio	100	55.2	29	22.2
Dyess AFB	99	51	32	25.8
El Paso	106	2.4	31	48
Ellington Af	95	10.2	29	37.2
Fort Worth	97	21	32	49.2
Ft Hood Aaf	97	43.2	31	9
Galveston	94	52.2	29	16.2
Gray AFB	97	49.8	31	4.2
Greenville	96	4.2	33	4.2
Guadalupe	104	4.8	31	49.8
Harlingen	97	40.2	26	13.8
Hondo	99	10.2	29	21
Houston	95	21	29	58.2
Junction	99	46.2	30	30
Kelly AFB	98	34.8	29	22.8
Kerrville	99	4.8	29	58.8
Killeen	97	40.8	31	4.8
Kingsville	97	49.2	27	30
Laredo Intl	99	28.2	27	31.8
Laughlin AFB	100	46.8	29	22.2
Longview	94	43.2	32	22.8
Lubbock	101	49.2	33	39
Lufkin	94	45	31	13.8
Marfa	104	1.2	30	22.2
McAllen	98	13.8	26	10.8
Midland	102	10.8	31	57
Mineral Wils	98	4.2	32	46.8
Palacios	96	15	28	43.2
Paris/Cox	95	27	33	37.8
Plainview	101	42.6	34	10.2
Port Arthur	94	1.2	30	34.8
Reese AFB	102	3	33	36
Rockport	97	1.8	28	4.8

	LONGITUDE		LATITUDE	
	degrees	min	degrees	min
San Angelo	100	3	31	22.2
San Antonio	98	28.2	29	31.8
Sanderson	102	25.2	30	10.2
South Brazos	95	52.2	28	1.8
Stephenville	98	10.8	32	13.2
Temple	97	25.2	31	9
Tyler/Pounds	95	2.4	32	22.2
Victoria	96	55.2	28	51
Wichita Fls	98	3	33	58.8
Wink	103	1.2	31	46.8
UTAH				
Blanding	109	46.8	38	1.8
Bullfrog Mar	110	4.2	37	30
Cedar City	113	0.6	37	42
Delta	112	34.8	39	19.8
Eagle Range	113	4.2	41	3
Green River	110	9	39	0
Hanksville	110	43.2	38	22.2
Hill AFB	111	58.2	41	7.2
Logan	111	51	41	46.8
Milford	113	1.8	38	43.2
Moab	109	45	38	46.2
Ogden	112	1.2	41	10.8
Price/Carbon	110	45	39	37.2
Provo	111	43.2	40	13.2
Roosevelt	110	37.8	40	30
Saint George	113	3.6	37	4.8
Salt Lake Ct	111	58.2	40	46.8
Tooele	112	1.2	40	10.2
Vernal	109	31.2	40	27
Wendover	114	3	41	13.2
VERMONT				
Burlington	73	9	44	28.2
Montpelier	72	34.2	44	12
Newport	72	19.8	45	33
Rutland	73	57	43	31.8
St Johnsbury	72	1.2	44	25.2
Wilmington	72	52.8	42	52.8
VIRGINIA				
Charlottes	78	27	38	7.8
Chesapeake	76	1.2	37	30
Danville	79	19.8	36	34.2
Fort Belvoir	77	10.8	38	43.2
Fort Eustis	76	37.2	37	7.8
Hot Springs	79	49.2	37	57
Langley AFB	76	22.2	37	4.8
Lynchburg	79	1.2	37	19.8
Newport	76	3	37	7.8
News				
Norfolk NAS	76	16.8	36	55.8
Norfolk Rgnl	76	1.2	36	54
Oceana NAS	76	1.8	36	49.2
Quantico Mca	77	1.8	38	30
Richmond	77	19.8	37	30
Roanoke	79	58.2	37	19.2
Muni				
Staunton	78	51	38	16.2
Volens	78	58.8	36	57
Wallops Sta	75	28.8	37	51
WASHINGTON				
Bellingham	122	31.8	48	48
Bremerton	122	46.2	47	28.8
Burlington	122	19.8	48	30
Colville	118	28.2	48	52.8
Ephrata	119	31.2	47	19.2
Everet/Paine	122	16.8	47	55.2
Fairchild	117	39	47	37.2
Fort Lewis	122	34.8	47	4.8
Hanford	119	3.6	46	34.2
Hoquiam	123	58.2	46	58.2
Mchord AFB	122	28.8	47	9
Moses Lake	119	19.2	47	12
Oak Harbor	122	40.8	48	15
Olympia	122	5.4	46	58.2
Omak	119	31.8	48	25.2
Pasco	119	7.2	46	16.2
Port Angeles	123	3	48	7.2
Pullman	117	7.2	46	45
Quillayute	124	33	47	57
Renton	122	13.2	47	30
Seattle	122	1.8	47	27
Shelton	123	9	47	15
Spokane	117	31.8	47	37.8
Tacoma	122	34.8	47	16.2
Toledo	122	4.8	46	28.8

	LONGITUDE		LATITUDE	
	degrees	min	degrees	min
Walla Walla	118	16.8	46	6
Wenatchee	120	1.2	47	24
Whidbey Is	122	39	48	21
Yakima	120	31.8	46	34.2
WEST VIRGINIA				
Beckley	81	7.2	37	46.8
Bluefield	81	13.2	37	18
Charleston	81	3.6	38	22.2
Clarksburg	80	13.8	39	16.8
Elkins	79	51	38	52.8
Huntington	82	33	38	22.2
Lewisburg	80	2.4	37	52.2
Martinsburg	77	58.8	39	24
Morgantown	79	55.2	39	39
Parkersburg	81	25.8	39	21
Wheeling	80	39	40	10.8
Wh Sulphur	80	1.2	37	27.6

	LONGITUDE		LATITUDE	
	degrees	min	degrees	min
WISCONSIN				
Appleton	88	31.2	44	15
Eau Claire	91	28.8	44	52.2
Green Bay	88	7.8	44	28.8
Janesville	89	1.8	42	37.2
La Crosse	91	15	43	52.2
Lone Rock	90	10.8	43	12
Madison	89	19.8	43	7.8
Manitowac	87	40.2	44	7.8
Milwaukee	87	5.4	42	57
Mosinee	89	40.2	44	46.8
Neenah	88	31.8	44	13.2
Oshkosh	88	34.2	44	0
Rhineland	89	27	45	37.8
Rice Lake	91	43.2	45	28.8
Volk Fld	90	16.2	43	55.8
Wausau	89	37.2	44	55.2

	LONGITUDE		LATITUDE	
	degrees	min	degrees	min
WYOMING				
Big Piney	110	0.6	42	34.2
Casper	106	28.2	42	55.2
Cheyenne	104	49.2	41	9
Cody	109	1.2	44	31.2
Douglas	105	22.8	42	45
Evanston	111	0	41	19.8
Gillette	105	31.8	44	21
Jackson	110	43.8	43	36
Lander	108	43.8	42	49.2
Laramie	105	40.8	41	19.2
Moorcroft	104	48.6	44	21
Rawlins	107	1.2	41	48
Riverton	108	27	43	3
Rock Springs	109	4.2	41	36
Sheridan	106	58.2	44	46.2
Worland	107	58.2	43	58.2
Yellowstone	110	25.2	44	33

CANADA

CITY	PROVINCE	LONGITUDE	LATITUDE
Calgary	Alberta	114 7	51 14
Churhill	Newfoundland	94 0	58 45
Coppermine	Northwest Terr.	115 21	67 49
Edmonton	Alberta	113 25	53 34
Frederickton	New Brunswick	66 40	45 57
Ft Mcpherson	Northwest Terr	134 50	67 29
Goose Bay	Newfoundland	60 20	53 15
Halifax	Nova Scotia	63 34	44 39
Hazelton	BC	127 38	55 15
Kenora	Ontario	94 29	49 47
Labrador City	Labrador	66 52	56 56
Montreal	Quebec	73 39	45 32
Mt. Logan	Yukon	140 24	60 34
Nakina	Yukon	132 48	59 12
Ottawa	Ontario	75 45	45 18
Peace River	Alberta	117 18	56 15
Pr. Edward Isl	Nova Scotia	63 9	46 14
Quebec	Quebec	71 15	46 50
Regina	Saskatchewan	104 38	50 30
Saskatoon	Saskatchewan	101 32	52 10
St. Johns	Newfoundland	52 43	47 34
Toronto	Ontario	79 23	43 39
Vancouver	BC	123 7	49 16
Victoria	BC	123 20	48 26
Whitehorse	Yukon	135 3	60 43
Winnipeg	Manitoba	97 9	49 53

CITY	COUNTRY	LONGITUDE	LATITUDE
Glasgow	Scotland	4 15 w	55 50 n
Guatemala City	Guatemala	90 31 w	14 37 n
Guayaquil	Ecuador	79 56 w	2 10 s
Hamburg	Germany	10 2 e	53 33 n
Hammerfest	Norway	23 38 e	70 38 n
Havana	Cuba	82 23 w	23 8 n
Helsinki	Finland	25 0 e	60 10 n
Hobart	Tasmania	147 19 e	42 52 s
Iquique	Chile	70 7 w	20 10 s
Irkutsk	Russia	104 20 e	52 30 n
Jakarta	Indonesia	106 48 e	6 16 s
Johannesburg	South Africa	28 4 e	26 12 s
Kingston	Jamaica	76 49 w	17 59 n
La Paz	Bolivia	68 22 w	16 27 s
Leeds	England	1 30 w	53 45 n
Lima	Peru	77 2 w	12 0 s
Liverpool	England	3 0 w	53 25 n
London	England	0 5 w	51 32 n
Lyons	France	4 50 e	45 45 n
Madrid	Spain	3 42 w	40 26 n
Manchester	England	2 15 w	53 30 n
Manila	Philippines	120 57 e	14 35 n
Marseilles	France	5 20 e	43 20 n
Mazatlán	Mexico	106 25 w	23 12 n
Mecca	Saudi Arabia	39 45 e	21 29 n
Melbourne	Australia	144 58 e	37 47 s
Mexico City	Mexico	99 7 w	19 26 n
Milan	Italy	9 10 e	45 27 n
Montevideo	Uruguay	56 10 w	34 53 s
Moscow	Russia	37 36 e	55 45 n
Munich	Germany	11 35 e	48 8 n
Nagasaki	Japan	129 57 e	32 48 n
Nagoya	Japan	136 56 e	35 7 n
Nairobi	Kenya	36 55 e	1 25 s
Nanjing	China	118 53 e	32 3 n
Naples	Italy	14 15 e	40 50 n
Newcastle	England	1 37 w	54 58 n
Odessa	Ukraine	30 48 e	46 27 n
Osaka	Japan	135 30 e	34 32 n
Oslo	Norway	10 42 e	59 57 n
Panama City	Panama	79 32 w	8 58 n
Paramaribo	Surinam	55 15 w	5 45 n
Paris	France	2 20 e	48 48 n
Beijing	China	116 25 e	39 55 n
Perth	Australia	115 52 e	31 57 s
Plymouth	England	4 5 w	50 25 n
Rio de Janeiro	Brazil	43 12 w	22 57 s
Rome	Italy	12 27 e	41 54 n
Salvador	Brazil	38 27 w	12 56 s
Santiago	Chile	70 45 w	33 28 s
St. Petersburg	Russia	30 18 e	59 56 n
Sao Paulo	Brazil	46 31 w	23 31 s
Shanghai	China	121 28 e	31 10 n
Sofia	Bulgaria	23 20 e	42 40 n
Stockholm	Sweden	18 3 e	59 17 n
Sydney	Australia	151 0 e	34 0 s
Tananarive	Madagascar	47 33 e	18 50 s
Teheran	Iran	51 45 e	35 45 n
Tokyo	Japan	139 45 e	35 40 n
Tripoli	Libya	13 12 e	32 57 n
Venice	Italy	12 20 e	45 26 n
Veracruz	Mexico	96 10 w	19 10 n
Vienna	Austria	16 20 e	48 14 n
Warsaw	Poland	21 0 e	52 14 n
Wellington	New Zealand	174 47 e	41 17 s
Zürich	Switzerland	8 31 e	47 21 n

INTERNATIONAL

Aberdeen	Scotland	2 9 w	57 9 n
Adelaide	Australia	138 36 e	34 55 s
Amsterdam	Holland	4 53 e	52 22 n
Ankara	Turkey	32 55 e	39 55 n
Asunción	Paraguay	57 40 w	25 15 s
Athens	Greece	23 43 e	37 58 n
Auckland	New Zealand	174 45 e	36 52 s
Bangkok	Thailand	100 30 e	13 45 n
Barcelona	Spain	2 9 e	41 23 n
Belém	Brazil	48 29 w	1 28 s
Belfast	Northern Ireland	5 56 w	54 37 n
Belgrade	Yugoslavia	20 32 e	44 52 n
Berlin	Germany	13 25 e	52 30 n
Birmingham	England	1 55 w	52 25 n
Bombay	India	72 48 e	19 0 n
Bordeaux	France	0 31 w	44 50 n
Bremen	Germany	8 49 e	53 5 n
Brisbane	Australia	153 8 e	27 29 s
Bristol	England	2 35 w	51 28 n
Brussels	Belgium	4 22 e	50 52 n
Bucharest	Romania	26 7 e	44 25 n
Budapest	Hungary	19 5 e	47 30 n
Buenos Aires	Argentina	58 22 w	34 35 s
Cairo	Egypt	31 21 e	30 2 n
Canton	China	113 15 e	23 7 n
Cape Town	South Africa	18 22 e	33 55 s
Caracas	Venezuela	67 2 w	10 28 n
Chihuahua	Mexico	106 5 w	28 37 n
Chongqing	China	106 34 e	29 46 n
Copenhagen	Denmark	12 34 e	55 40 n
Córdoba	Argentina	64 10 w	31 28 s
Darwin	Australia	130 51 e	12 28 s
Dublin	Ireland	6 15 w	53 20 n
Durban	South Africa	30 53 e	29 53 s
Edinburgh	Scotland	3 10 w	55 55 n
Frankfurt	Germany	8 41 e	50 7 n
Georgetown	Guyana	58 15 w	6 45 n

Appendix D - RS-232 Connection

Using the included NexRemote software you can control your CPC telescope with a computer via the RS-232 port located on the computerized hand control and using the RS-232 cable (#93920). For information about using NexRemote to control your telescope, refer to the instruction sheet that came with the NexRemote CD and the help files located on the disk. In addition to NexRemote, the CPC can be controlled using other popular astronomy software programs. For detailed information about controlling the CPC via the RS-232 port, Communication protocols and the RS-232 cable, refer to the CPC section of the Celestron web site at: <http://www.celestron.com/cpc>.

APPENDIX E – MAPS OF TIME ZONES

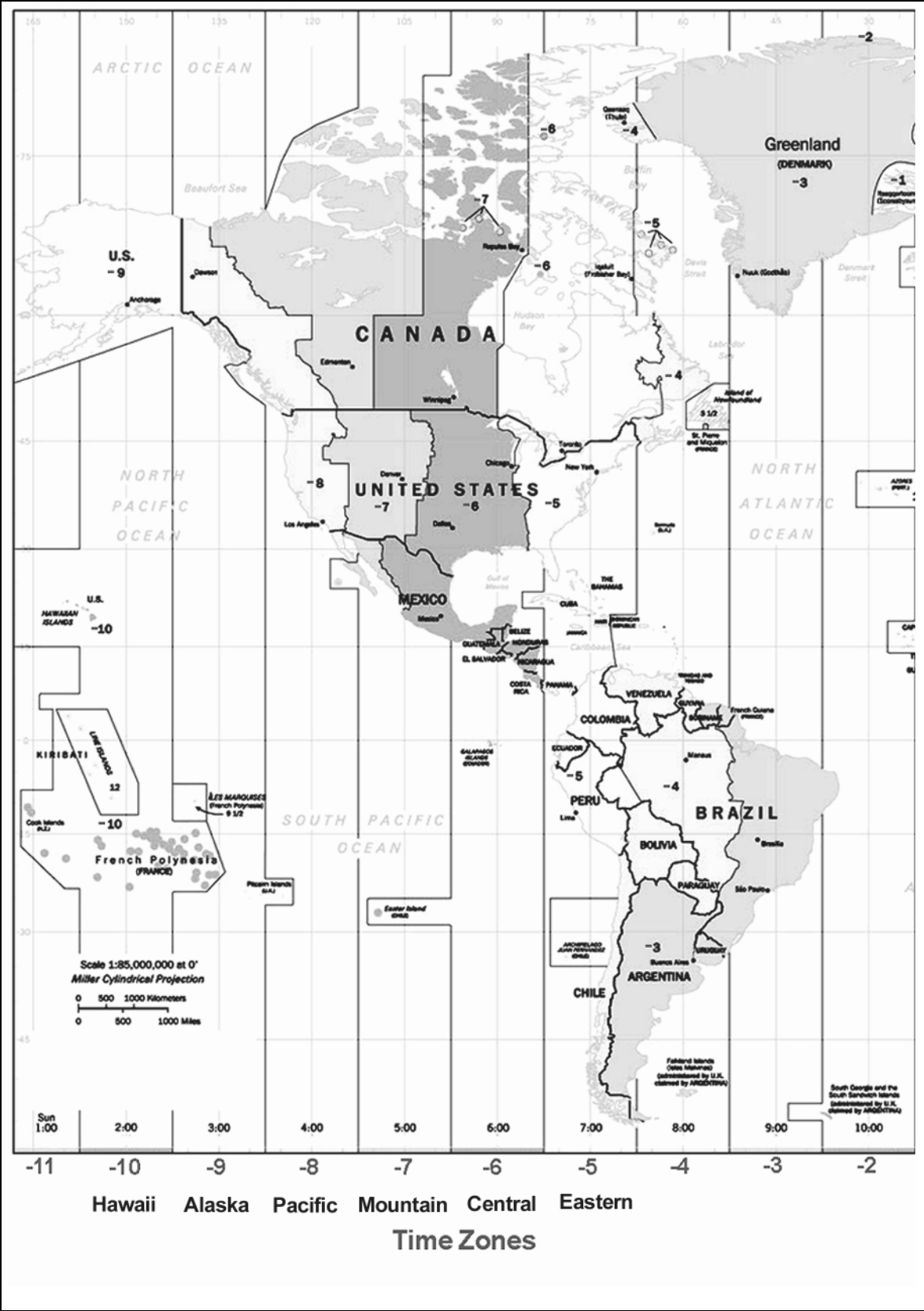

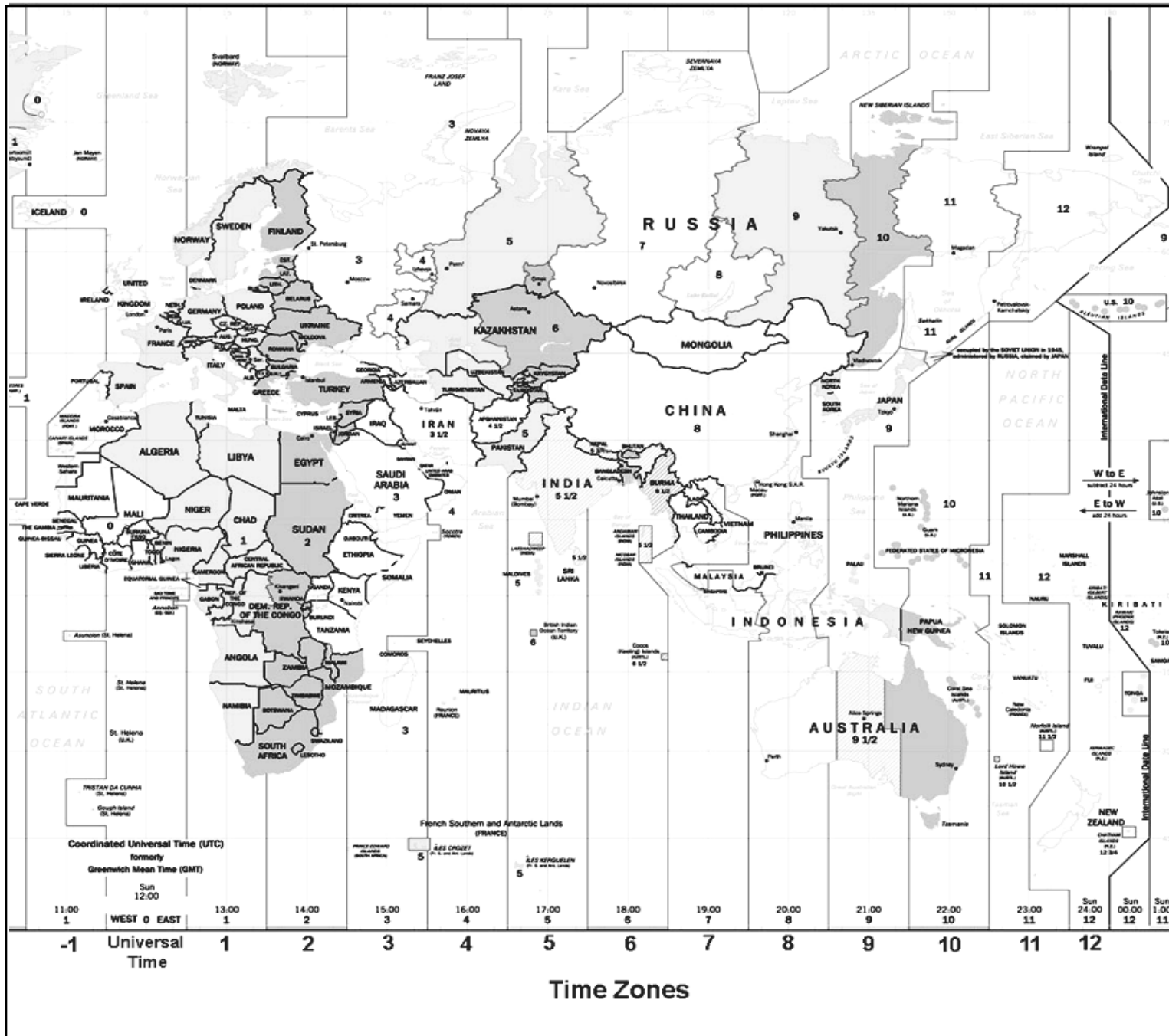

January - February Sky

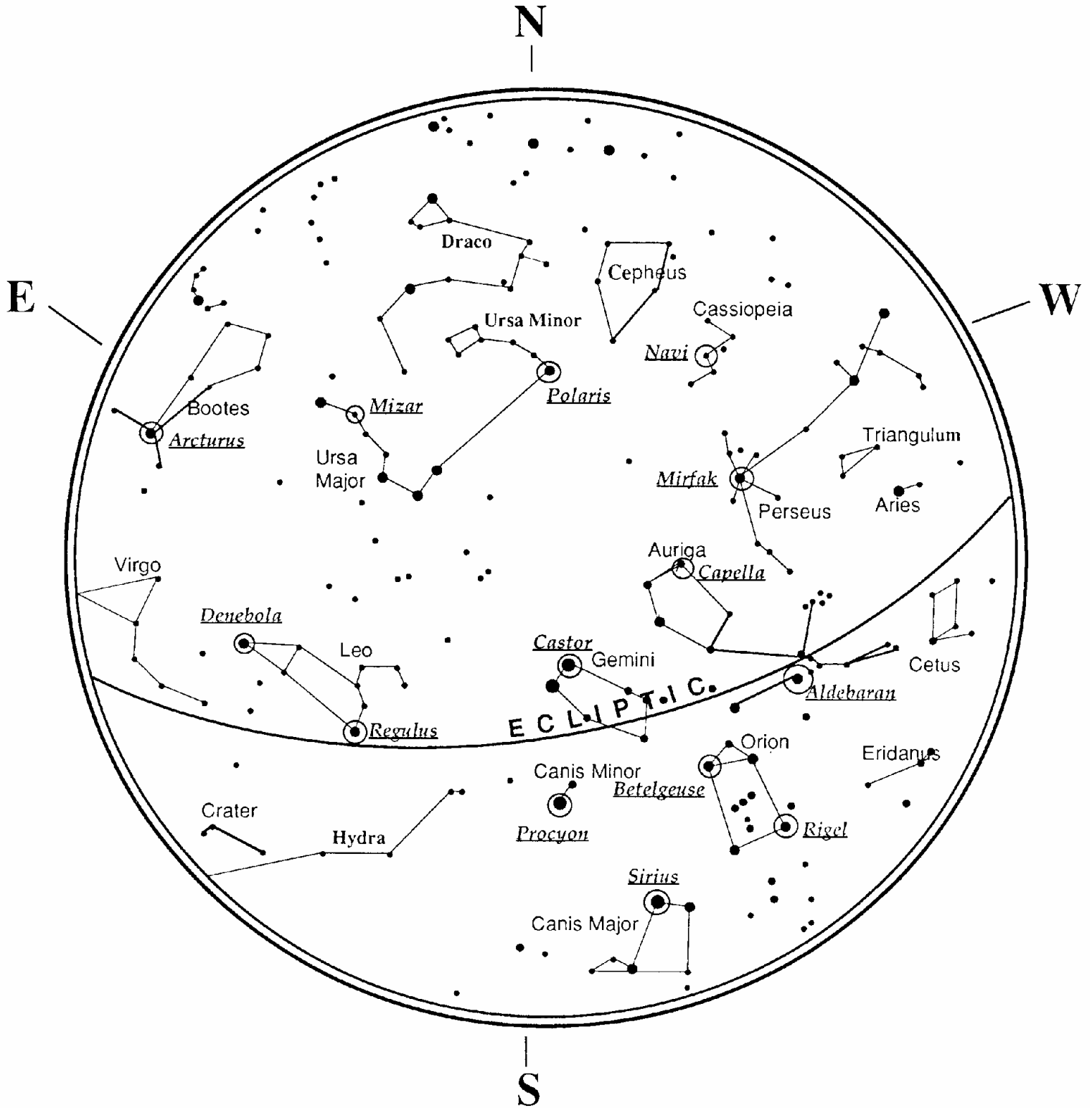

March - April Sky

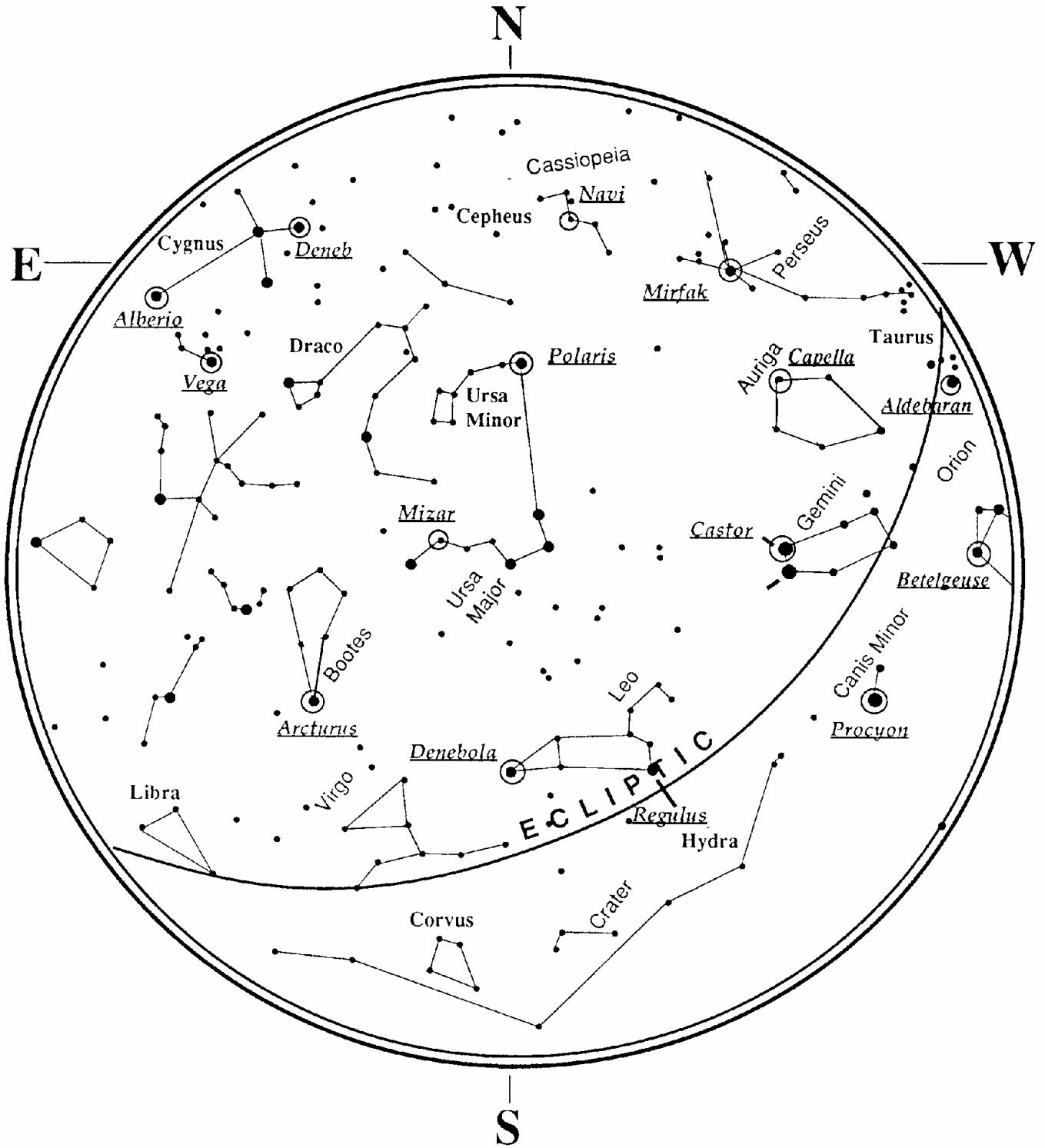

May - June Sky

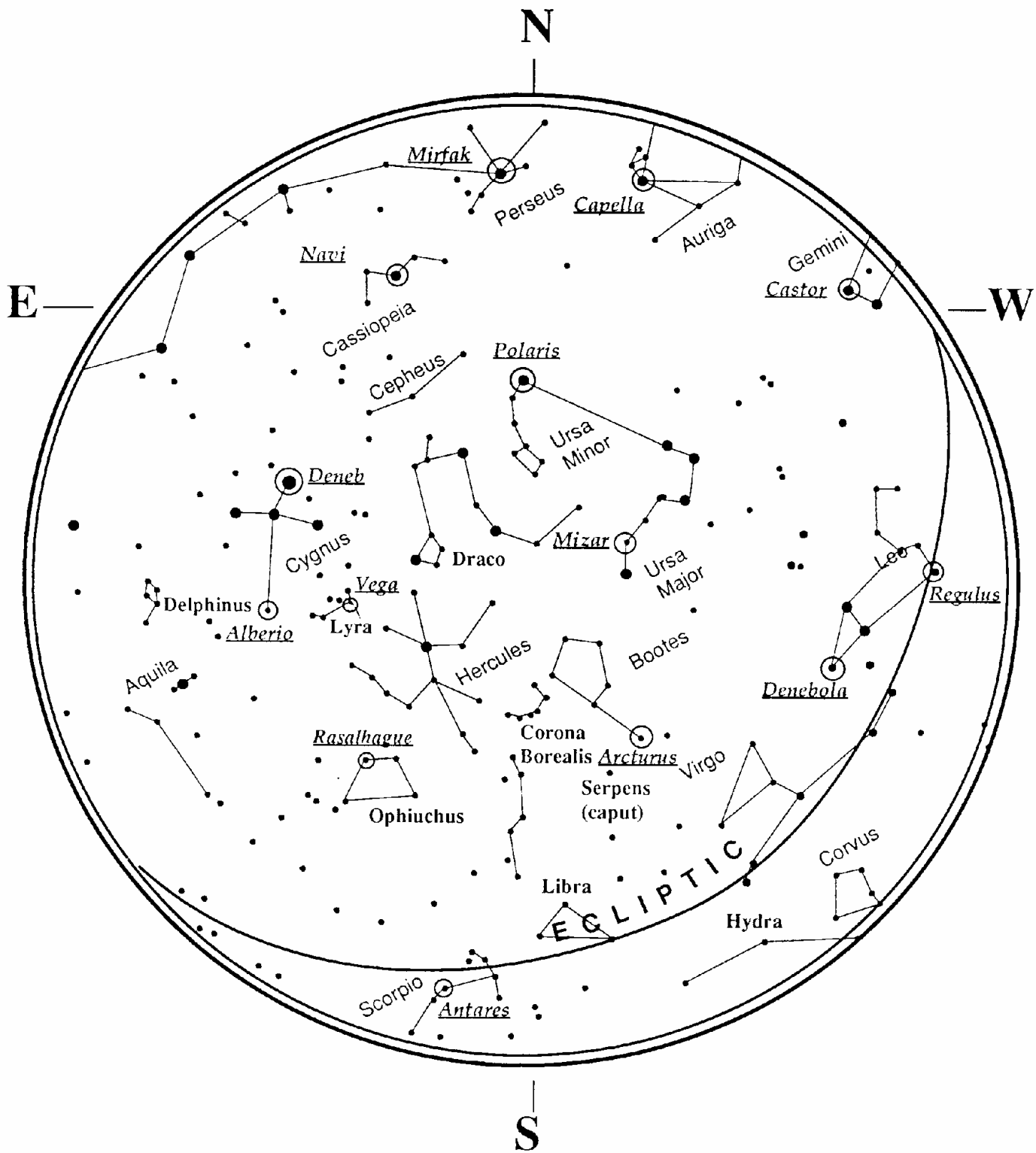

July - August Sky

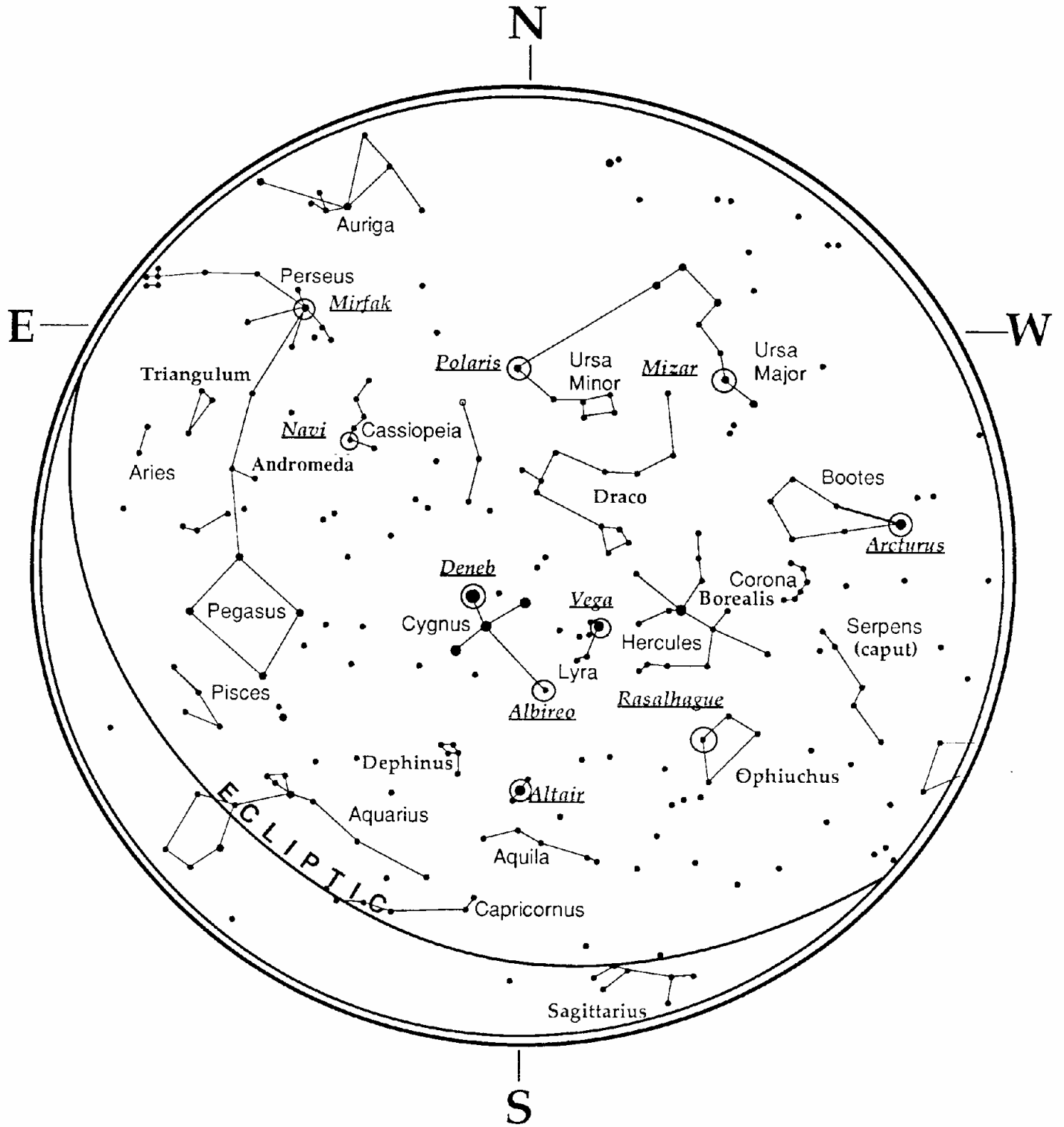

September - October Sky

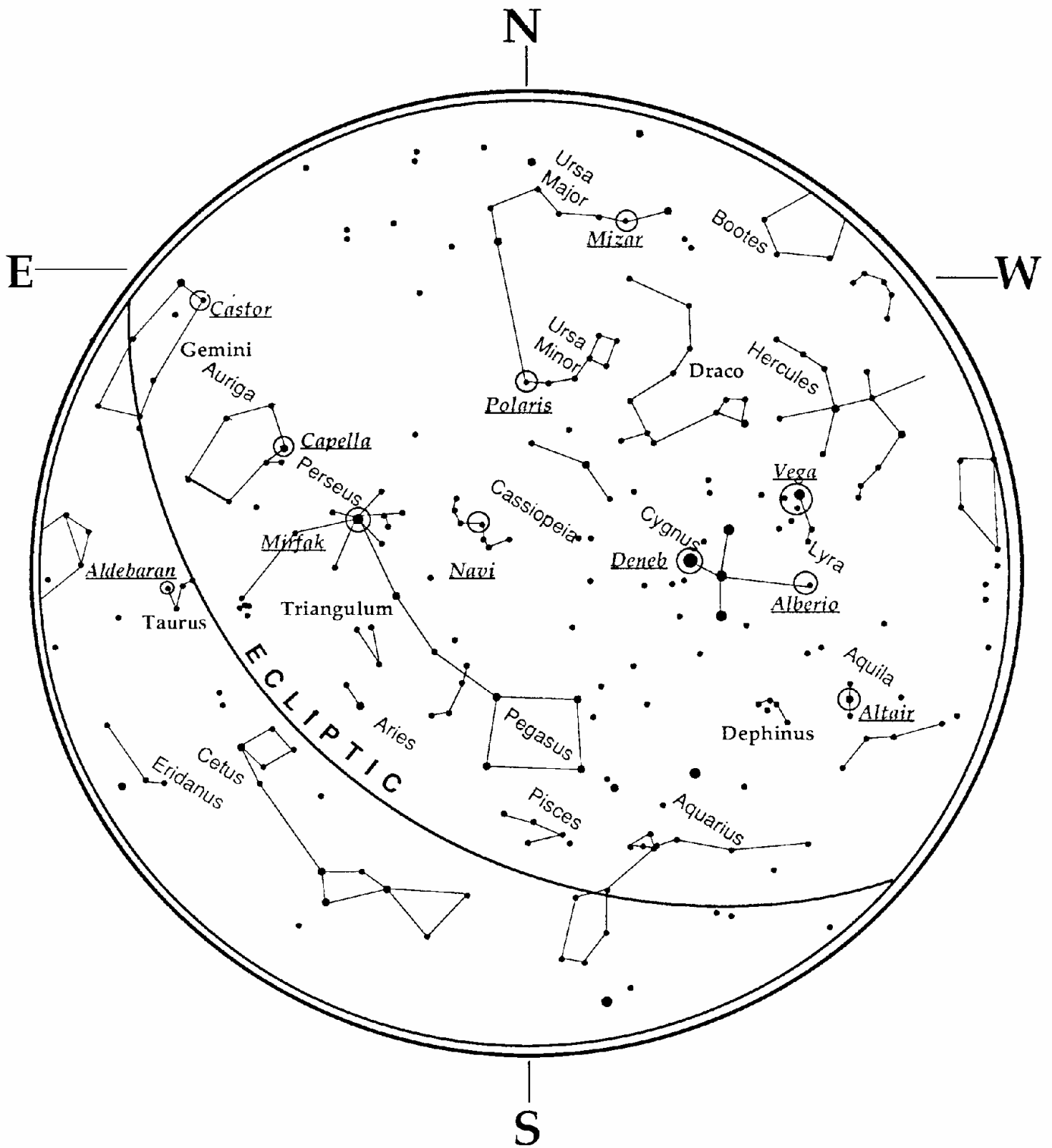

November - December Sky

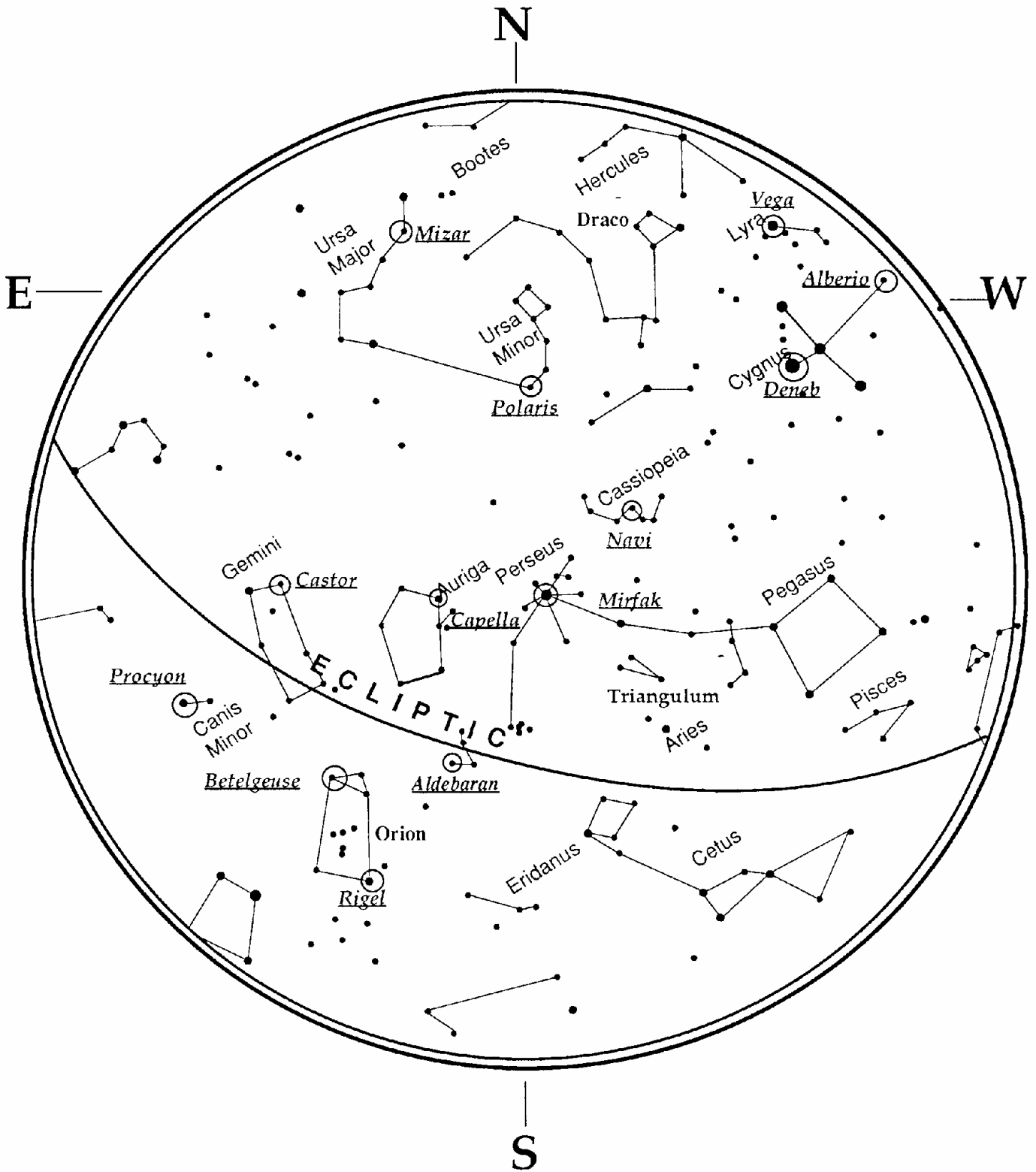

CELESTRON TWO YEAR WARRANTY

- A. Celestron warrants this telescope to be free from defects in materials and workmanship for two years. Celestron will repair or replace such product or part thereof which, upon inspection by Celestron, is found to be defective in materials or workmanship. As a condition to the obligation of Celestron to repair or replace such product, the product must be returned to Celestron together with proof-of-purchase satisfactory to Celestron.
- B. The Proper Return Authorization Number must be obtained from Celestron in advance of return. Call Celestron at (310) 328-9560 to receive the number to be displayed on the outside of your shipping container.

All returns must be accompanied by a written statement setting forth the name, address, and daytime telephone number of the owner, together with a brief description of any claimed defects. Parts or product for which replacement is made shall become the property of Celestron.

The customer shall be responsible for all costs of transportation and insurance, both to and from the factory of Celestron, and shall be required to prepay such costs.

Celestron shall use reasonable efforts to repair or replace any telescope covered by this warranty within thirty days of receipt. In the event repair or replacement shall require more than thirty days, Celestron shall notify the customer accordingly. Celestron reserves the right to replace any product which has been discontinued from its product line with a new product of comparable value and function.

This warranty shall be void and of no force of effect in the event a covered product has been modified in design or function, or subjected to abuse, misuse, mishandling or unauthorized repair. Further, product malfunction or deterioration due to normal wear is not covered by this warranty.

CELESTRON DISCLAIMS ANY WARRANTIES, EXPRESS OR IMPLIED, WHETHER OF MERCHANTABILITY OF FITNESS FOR A PARTICULAR USE, EXCEPT AS EXPRESSLY SET FORTH HEREIN.

THE SOLE OBLIGATION OF CELESTRON UNDER THIS LIMITED WARRANTY SHALL BE TO REPAIR OR REPLACE THE COVERED PRODUCT, IN ACCORDANCE WITH THE TERMS SET FORTH HEREIN. CELESTRON EXPRESSLY DISCLAIMS ANY LOST PROFITS, GENERAL, SPECIAL, INDIRECT OR CONSEQUENTIAL DAMAGES WHICH MAY RESULT FROM BREACH OF ANY WARRANTY, OR ARISING OUT OF THE USE OR INABILITY TO USE ANY CELESTRON PRODUCT. ANY WARRANTIES WHICH ARE IMPLIED AND WHICH CANNOT BE DISCLAIMED SHALL BE LIMITED IN DURATION TO A TERM OF TWO YEARS FROM THE DATE OF ORIGINAL RETAIL PURCHASE.

Some states do not allow the exclusion or limitation of incidental or consequential damages or limitation on how long an implied warranty lasts, so the above limitations and exclusions may not apply to you.

This warranty gives you specific legal rights, and you may also have other rights which vary from state to state.

Celestron reserves the right to modify or discontinue, without prior notice to you, any model or style telescope.

If warranty problems arise, or if you need assistance in using your telescope contact:

Celestron
Customer Service Department
2835 Columbia Street
Torrance, CA 90503
Tel. (310) 328-9560
Fax. (310) 212-5835
Monday-Friday 8AM-4PM PST

This warranty supersedes all other product warranties.

NOTE: This warranty is valid to U.S.A. and Canadian customers who have purchased this product from an Authorized Celestron Dealer in the U.S.A. or Canada. Warranty outside the U.S.A. and Canada is valid only to customers who purchased from a Celestron Distributor or Authorized Celestron Dealer in the specific country and please contact them for any warranty service.



Celestron
2835 Columbia Street
Torrance, CA 90503
Tel. (310) 328-9560
Fax. (310) 212-5835
Web site at <http://www.celestron.com>

Copyright 2005 Celestron
All rights reserved.

(Products or instructions may change
without notice or obligation.)

Item # 11073-INST
\$10.00
04-05